

*the spoken  
qualität quality  
über die man spricht*

€ Price List  
Preis Liste

01.01.2018





 **AKKO®**









We as AKKO Oto. Mak. Hird. San. Tic. Ltd. Şti, which has been founded by Abdullah KARAKUŞ in 1986, produce Turning Tool Holders, Threading and Grooving Tool Holders, U-Drills, Milling Tool Holders and Precision Tool Holders ( OEM Tool Holders ). We produce standard 6000 kinds of tool holders with production capacity of 300.000 pieces per annum in an area about 8000 square meter. We are going on exporting 61 countries including European, Asian, African, Asian, South American Countries and Middle East Countries. We keep ready about 200.000 pieces produced products in our stock. Steel Raw materials that we make produced especially for us are delivered our factory and all production process are made in our factory. All kind of process from machining of steel to heat treatment and coating on our tools are made in our integrated factory AKKO.





Die Fa.Akko, die 1986 von Abdullah Karakus gegründet wurde, produziert Drehhalter für ISO-Wendeplatten, Gewinderehalter, Stechwerkzeuge, Wendeplattenbohrer, Fräswerkzeuge und Präzisionswendeplattenwerkzeuge (OEM). Auf 8000 m<sup>2</sup> fertigen wir 6000 verschiedene Artikel mit einer Gesamtkapazität von 300.000 Stück pro Jahr. Wir exportieren unsere Produkte weltweit in 61 verschiedene Länder und beliefern unsere Kunden in Europa, Asien, Afrika, Südamerika und Mittlerer Osten. Unser Lagerbestand beträgt ca.200.000 Stück. Das von uns verarbeitete Rohmaterial wird speziell für uns gefertigt und alle Fertigungsschritte werden in unserer eigenen Produktion durchgeführt. Dazu zählen die mechanische Bearbeitung, die Wärmebehandlung und die Beschichtung.

T - SYSTEM EXTERNAL TURNING TOOLHOLDERS / AUBEN - DREHHALTER			PRICE / PREIS
 <p>75°</p>	<b>TCBNR / L</b> CNM. 1606..	2525 M16	61,00 €
 <p>75°</p>	<b>TCKNR / L</b> CNM. 1204.. CNM. 1606..	2020 K12	58,00 €
		2525 M12	59,00 €
		2525 M16	61,00 €
		3232 P12	67,00 €
		3232 P16	70,00 €
 <p>95°</p>	<b>TCLNR / L</b> CNM. 1204.. CNM. 1606..	2020 K12	58,00 €
		2525 M12	59,00 €
		3232 P12	67,00 €
		4040 S12	112,00 €
		5050 S12	158,00 €
		2525 M16	61,00 €
		3232 P16	70,00 €
 <p>50°</p>	<b>TCMNN</b> CNM. 1204.. CNM. 1606..	1616 H12	57,00 €
		2020 K12	58,00 €
		2525 M12	59,00 €
		3232 P12	67,00 €
		2525 M16	61,00 €
		3232 P16	70,00 €
 <p>40°</p>	<b>TCZNN</b> CNM. 1204.. CNM. 1606..	2020 K12	58,00 €
		2525 M12	59,00 €
		3232 P12	67,00 €
		2525 M16	61,00 €
		3232 P16	70,00 €
 <p>NEW</p> <p>107.5°</p>	<b>TDHNR / L</b> DNM. 1506..	2020 K15	58,00 €
		2525 M15	59,00 €
		3232 P15	67,00 €

T - SYSTEM EXTERNAL TURNING TOOLHOLDERS / AUBEN - DREHHALTER			PRICE / PREIS
 <p><b>TDJNR / L</b> DNM. 1104.. DNM. 1504.. DNM. 1506..</p> <p>93°</p>	1616 H11	57,00 €	
	2020 K11	58,00 €	
	2525 M11	59,00 €	
	2020 K15	58,00 €	
	2525 M15	59,00 €	
	3232 P15	67,00 €	
	4040 S15	112,00 €	
	2020 K1504	58,00 €	
	2525 M1504	59,00 €	
	3232 P1504	67,00 €	
	4040 S1504	112,00 €	
 <p><b>TDNNN</b> DNM. 1104.. DNM. 1506..</p> <p>62.5°</p>	1616 H11	57,00 €	
	2020 K11	58,00 €	
	2525 M11	59,00 €	
	2020 K15	58,00 €	
	2525 M15	59,00 €	
3232 P15	67,00 €		
 <p><b>TSDNN</b> SNM. 1204..</p> <p>45°</p>	1616 H12	57,00 €	
	2020 K12	58,00 €	
	2525 M12	59,00 €	
	3232 P12	67,00 €	
 <p><b>TSKNR / L</b> SNM. 1204.. SNM. 1506..</p> <p>75°</p>	2020 K12	58,00 €	
	2525 M12	59,00 €	
	3232 P12	67,00 €	
	3232 P15	70,00 €	
 <p><b>TSSNR / L</b> SNM. 1204.. SNM. 1506..</p> <p>45°</p>	2020 K12	58,00 €	
	2525 M12	59,00 €	
	3232 P12	67,00 €	
	2525 M15	61,00 €	
	3232 P15	70,00 €	

T - SYSTEM EXTERNAL TURNING TOOLHOLDERS / AUBEN - DREHHALTER			PRICE / PREIS
 <p><b>TTENN</b> TNM. 1604.. TNM. 2204..</p> <p>60°</p>	2020 K16	58,00 €	
	2525 M16	59,00 €	
	3232 P16	67,00 €	
	2525 M22	59,00 €	
	3232 P22	67,00 €	
 <p><b>TTGNR / L</b> TNM. 1604.. TNM. 2204..</p> <p>90°</p>	2020 K16	58,00 €	
	2525 M16	59,00 €	
	<small>NEW</small> 3232 P16	67,00 €	
	2525 M22	59,00 €	
	3232 P22	67,00 €	
 <p><b>TTJNR / L</b> TNM. 1604.. TNM. 2204..</p> <p>93°</p>	2020 K16	58,00 €	
	2525 M16	59,00 €	
	3232 P16	67,00 €	
	2525 M22	59,00 €	
	3232 P22	67,00 €	
 <p><b>TVHNR / L</b> VNM. 1604..</p> <p>107.5°</p>	2020 K16	58,00 €	
	2525 M16	59,00 €	
	<small>NEW</small> 3232 P16	67,00 €	
 <p><b>TVJNR / L</b> VNM. 1604..</p> <p>93°</p>	2020 K16	58,00 €	
	2525 M16	59,00 €	
	3232 P16	67,00 €	
 <p><b>TVVNN</b> VNM. 1604..</p> <p>72.5°</p>	2020 K16	58,00 €	
	2525 M16	59,00 €	
	3232 P16	67,00 €	

T - SYSTEM EXTERNAL TURNING TOOLHOLDERS / AUBEN - DREHHALTER			PRICE / PREIS
 <p><b>TWLNR / L</b> WNM. 0604.. WNM. 0804..</p> <p>95°</p>	1616 H06	57,00 €	
	2020 K06	58,00 €	
	2525 M06	59,00 €	
	2020 K08	58,00 €	
	2525 M08	59,00 €	
	3232 P08	67,00 €	
	NEW 4040 S08	112,00 €	

M - SYSTEM EXTERNAL TURNING TOOLHOLDERS / AUBEN - DREHHALTER			PRICE / PREIS
 <p><b>MTENN</b> TNM. 1604.. TNM. 2204..</p> <p>60°</p>	2020 K16	58,00 €	
	2525 M16	59,00 €	
	3232 P16	67,00 €	
	2525 M22	59,00 €	
	3232 P22	67,00 €	
	NEW 4040 S22	112,00 €	





 <p><b>MTJNR / L</b> TNM. 1604.. TNM. 2204..</p> <p>93°</p>	2020 K16	58,00 €
	2525 M16	59,00 €
	3232 P16	67,00 €
	2525 M22	59,00 €
	3232 P22	67,00 €
	4040 S22	112,00 €

 <p><b>MWLNR / L</b> WNM. 0604.. WNM. 0804..</p> <p>95°</p>	1616 H06	57,00 €
	2020 K06	58,00 €
	2525 M06	59,00 €
	2020 K08	58,00 €
	2525 M08	59,00 €
	3232 P08	67,00 €

 <p><b>MWMNN</b> WNM. 0604.. WNM. 0804..</p> <p>50°</p>	1616 H06	57,00 €
	2020 K06	58,00 €
	2525 M06	59,00 €
	2020 K08	58,00 €
	2525 M08	59,00 €
	3232 P08	67,00 €



P - SYSTEM EXTERNAL TURNING TOOLHOLDERS / AUßEN - DREHHALTER			PRICE / PREIS
 <p><b>PCBNR / L</b></p> <p>CNM. 1204.. CNM. 1606.. CNM. 1906.. CNM. 2509..</p> <p><b>75°</b></p>	2020 K12C	58,00 €	
	2525 M12C	59,00 €	
	3232 P12C	67,00 €	
	2525 M16C	61,00 €	
	3232 P16C	70,00 €	
	3232 P19C	88,00 €	
	4040 S19C	118,00 €	
4040 S25C	129,00 €		
 <p><b>PCLNR / L</b></p> <p>CNM. 0903.. CNM. 1204.. CNM. 1606.. CNM. 1906.. CNM. 2509..</p> <p><b>95°</b></p>	1616 H09	57,00 €	
	2020 K09	58,00 €	
	2525 M09	59,00 €	
	1616 H12	57,00 €	
	2020 K12C	58,00 €	
	2525 M12C	59,00 €	
	3232 P12C	67,00 €	
	2525 M16C	61,00 €	
	3232 P16C	70,00 €	
	2525 M19C	79,00 €	
	3232 P19C	88,00 €	
	4040 S19C	118,00 €	
	4040 S25C	129,00 €	
	5050 S25C	171,00 €	
 <p><b>PCMNN</b></p> <p>CNM. 1204.. CNM. 1906.. CNM. 2509..</p> <p><b>50°</b></p>	2020 K12C	58,00 €	
	2525 M12C	59,00 €	
	3232 P19C	88,00 €	
	4040 S25C	129,00 €	
 <p><b>PDJNR / L</b></p> <p>DNM. 1104.. DNM. 1506..</p> <p><b>93°</b></p>	1616 H11	57,00 €	
	2020 K11	58,00 €	
	2525 M11	59,00 €	
	2020 K15C	58,00 €	
	2525 M15C	59,00 €	
	3232 P15C	67,00 €	
	4040 S15C	112,00 €	
 <p><b>PDNNN</b></p> <p>DNM. 1104.. DNM. 1506..</p> <p><b>62.5°</b></p>	1616 H11	57,00 €	
	2020 K11	58,00 €	
	2525 M11	59,00 €	
	2020 K15C	58,00 €	
	2525 M15C	59,00 €	
	3232 P15C	67,00 €	



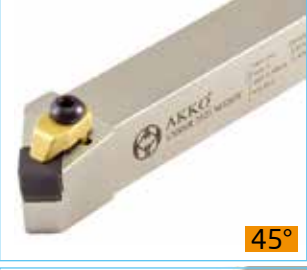

P - SYSTEM EXTERNAL TURNING TOOLHOLDERS / AUßEN - DREHHALTER			PRICE / PREIS
 <p><b>PSBNR / L</b></p> <p>SNM. 0903.. SNM. 1204.. SNM. 1506.. SNM. 1906.. SNM. 2509..</p> <p>75°</p>	1616 H09	57,00 €	
	2020 K12	58,00 €	
	2525 M12C	59,00 €	
	3232 P12C	67,00 €	
	NEW 2525 M15C	61,00 €	
	3232 P15C	70,00 €	
	3232 P19C	88,00 €	
	4040 S19C	118,00 €	
	4040 S25C	129,00 €	
	NEW 5050 S25C	171,00 €	
 <p><b>PSDNN</b></p> <p>SNM. 0903.. SNM. 1204.. SNM. 1506.. SNM. 1906.. SNM. 2509..</p> <p>45°</p>	1616 H09	57,00 €	
	2020 K12C	58,00 €	
	2525 M12C	59,00 €	
	3232 P12C	67,00 €	
	2525 M15C	61,00 €	
	3232 P19C	88,00 €	
	4040 S25C	129,00 €	
 <p><b>PSKNR / L</b></p> <p>SNM. 0903.. SNM. 1204.. SNM. 1506.. SNM. 1906.. SNM. 2509..</p> <p>75°</p>	2020 K09	58,00 €	
	2020 K12C	58,00 €	
	2525 M12C	59,00 €	
	3232 P12C	67,00 €	
	2525 M15C	61,00 €	
	3232 P15C	70,00 €	
	3232 P19C	88,00 €	
	4040 S19C	118,00 €	
	4040 S25C	129,00 €	
	5050 S25C	171,00 €	
 <p><b>PSSNR / L</b></p> <p>SNM. 0903.. SNM. 1204.. SNM. 1906.. SNM. 2509..</p> <p>45°</p>	1616 H09	57,00 €	
	2020 K09	58,00 €	
	2020 K12C	58,00 €	
	2525 M12C	59,00 €	
	3232 P12C	67,00 €	
	3232 P19C	88,00 €	
	4040 S19C	118,00 €	
	4040 S25C	129,00 €	
 <p><b>PTFNR / L</b></p> <p>TNM. 1604.. TNM. 2204..</p> <p>90°</p>	1616 H16	57,00 €	
	2020 K16	58,00 €	
	2525 M16	59,00 €	
	3232 P16	67,00 €	
	2525 M22C	59,00 €	
	3232 P22C	67,00 €	

P - SYSTEM EXTERNAL TURNING TOOLHOLDERS / AUßEN - DREHHALTER			PRICE / PREIS
 <p style="text-align: right;"><b>90°</b></p>	<b>PTGNR / L</b>  <b>TNM. 1604..</b> <b>TNM. 2204..</b>	1616 H16	57,00 €
		2020 K16	58,00 €
		2525 M16	59,00 €
		2525 M22C	59,00 €
		<small>NEW</small> 3232 P22C	67,00 €
 <p style="text-align: right;"><b>93°</b></p>	<b>PTJNR / L</b>  <b>TNM. 1604..</b> <b>TNM. 2204..</b>	1616 H16	57,00 €
		2020 K16	58,00 €
		2525 M16	59,00 €
		3232 P16	67,00 €
		2525 M22C	59,00 €
		3232 P22C	67,00 €
 <p style="text-align: right;"><b>60°</b></p>	<b>PTTNR / L</b>  <b>TNM. 1604..</b> <b>TNM. 2204..</b>	1616 H16	57,00 €
		2020 K16	58,00 €
		2525 M16	59,00 €
		3232 P16	67,00 €
		2525 M22C	59,00 €
		3232 P22C	67,00 €
 <p style="text-align: right;"><b>95°</b></p>	<b>PWLNR / L</b>  <b>WNM. 0604..</b> <b>WNM. 0804..</b>	1616 H06	57,00 €
		2020 K06	58,00 €
		2525 M06	59,00 €
		1616 H08	57,00 €
		2020 K08C	58,00 €
		2525 M08C	59,00 €
		3232 P08C	67,00 €
<b>C - SYSTEM EXTERNAL TURNING TOOLHOLDERS / AUßEN - DREHHALTER</b>			<b>PRICE / PREIS</b>
 <p style="text-align: right;"><b>93°</b></p>	<b>CKJNR / L</b>  <b>KNUX 1604..</b>	2020 K16	58,00 €
		2525 M16	59,00 €
		3232 P16	67,00 €
		4040 S16	129,00 €

C - SYSTEM EXTERNAL TURNING TOOLHOLDERS FOR CERAMIC INSERTS / AUßEN - DREHHALTER - FÜR KERAMIK WENDESCHNEIDPLATTEN			PRICE / PREIS
 <p><b>CCLNR / L</b> CN.N 1207.. CN.N 1607..</p> <p>95°</p>	2525 M1207C	80,00 €	
	3232 P1207C	90,00 €	
	<small>NEW</small> 2525 M1607C	89,00 €	
 <p><b>CDJNR / L</b> DN.N 1107.. DN.N 1507..</p> <p>93°</p>	2525 M1107C	80,00 €	
	2525 M1507C	80,00 €	
	3232 P1507C	90,00 €	
 <p><b>CDNNN</b> DN.N 1107..</p> <p>62.5°</p>	2525 M1107C	80,00 €	
 <p><b>CRDCN</b> RCGX 060600 RCGX 090700 RCGX 120700</p>	2525 M06CV	117,00 €	
	3225 P06CV	128,00 €	
	4040 S06CV	163,00 €	
	2525 M09CV	117,00 €	
	3225 P09CV	128,00 €	
	4040 S09CV	163,00 €	
	2525 M12CV	117,00 €	
	3225 P12CV	128,00 €	
4040 S12CV	163,00 €		
 <p><b>CSDNN</b> SN.N 1207..</p> <p>45°</p>	2525 M1207C	80,00 €	
	3232 P1207C	90,00 €	
 <p><b>CSKNR / L</b> SN.N 1207..</p> <p>75°</p>	2525 M1207C	80,00 €	
	3232 P1207C	90,00 €	

C - SYSTEM EXTERNAL TURNING TOOLHOLDERS FOR CERAMIC INSERTS / AUßEN - DREHHALTER - FÜR KERAMIK WENDESCHNEIDPLATTEN			PRICE / PREIS
 <p><b>CSRNR / L</b> SN.N 1207..</p> <p>45°</p>	2525 M1207C	80,00 €	
	3232 P1207C	90,00 €	
 <p><b>CSSNR / L</b> SN.N 1207..</p> <p>45°</p>	2525 M1207C	80,00 €	
	3232 P1207C	90,00 €	
 <p><b>CTJNR / L</b> TN.N 1607..</p> <p>93°</p>	2525 M1607C	80,00 €	
	3232 P1607C	90,00 €	

S - SYSTEM EXTERNAL TURNING TOOLHOLDERS / AUßEN - DREHHALTER			PRICE / PREIS
 <p><b>SCACR / L</b> CC.T 0602.. CC.T 09T3.. CC.T 1204..</p> <p>90°</p>	0808 E06	35,00 €	
	1010 E06	35,00 €	
	1212 F09	35,00 €	
	1616 H09	39,00 €	
	2020 K09	41,00 €	
	2020 K12	41,00 €	
	2525 M12-Z	41,00 €	
	2525 M12	43,00 €	
 <p><b>SCLCR / L</b> CC.T 0602.. CC.T 09T3.. CC.T 1204..</p> <p>95°</p>	0808 E06	35,00 €	
	1010 E06	35,00 €	
	1212 F09	35,00 €	
	1616 H09	39,00 €	
	2020 K09	41,00 €	
	2525 M09	43,00 €	
	2020 K12-Z	39,00 €	
	2020 K12	41,00 €	
2525 M12-Z	41,00 €		
2525 M12	43,00 €		
 <p><b>SCMCN</b> CC.T 0602.. CC.T 09T3.. CC.T 1204..</p> <p>50°</p>	0808 E06	35,00 €	
	1010 E06	35,00 €	
	<small>NEW</small> 1212 F06	35,00 €	
	1212 F09	35,00 €	
	1616 H09	39,00 €	
	2020 K12	41,00 €	
<small>NEW</small> 2525 M12			

S - SYSTEM EXTERNAL TURNING TOOLHOLDERS / AUßEN - DREHHALTER			PRICE / PREIS
 <p><b>107.5°</b></p>	<b>SDHCR / L</b>  DC.T 0702.. DC.T 11T3..	0808 E07	35,00 €
		1010 E07	35,00 €
		1212 F07	35,00 €
		1616 H07	35,00 €
		1616 H11	39,00 €
		2020 K11	41,00 €
		2525 M11	43,00 €
		3232 P11	49,00 €
 <p><b>93°</b></p>	<b>SDJCR / L</b>  DC.T 0702.. DC.T 11T3..	0808 E07	35,00 €
		1010 E07	35,00 €
		1212 F07	35,00 €
		1616 H07	35,00 €
		1616 H11	39,00 €
		2020 K11	41,00 €
		2525 M11	43,00 €
		3232 P11	49,00 €
 <p><b>62.5°</b></p>	<b>SDNCN</b>  DC.T 0702.. DC.T 11T3..	0808 E07	35,00 €
		1010 E07	35,00 €
		1212 F07	35,00 €
		1616 H07	35,00 €
		1616 H11	39,00 €
		2020 K11	41,00 €
		2525 M11	43,00 €
		3232 P11	49,00 €
 <p><b>R</b></p>	<b>SRDCN</b>  RC.T 0602.. RC.T 0803.. RC.T 10T3.. RC.T 1204.. RC.T 1605.. RC.T 2006.. RC.T 2507.. RC.T 3209..	1616 H06	39,00 €
		2020 K06	41,00 €
		2525 M06	43,00 €
		1616 H08C	39,00 €
		2020 K08C	41,00 €
		2525 M08C	43,00 €
		1616 H10C	39,00 €
		2020 K10C	41,00 €
		2525 M10C	43,00 €
		3232 P10C	49,00 €
		2020 K12C	41,00 €
		2525 M12C	43,00 €
		3232 P12C	49,00 €
		2525 M16C	46,00 €
		3232 P16C	52,00 €
		2525 M20C	90,00 €
		3232 P20C	106,00 €
		3232 P25C	106,00 €
		3232 P32C	106,00 €



S - SYSTEM EXTERNAL TURNING TOOLHOLDERS / AUßEN - DREHHALTER			PRICE / PREIS
 <p><b>SRDCR / L</b> RC.T 1204..</p> <p><b>R</b></p>	3232 P12C	49,00 €	
 <p><b>SRGCR / L</b> RC.T 0602.. RC.T 0803.. RC.T 10T3.. RC.T 1204..</p> <p><b>R</b></p>	1616 H06	39,00 €	
	2020 K06	41,00 €	
	1616 H08C	39,00 €	
	2020 K08C	41,00 €	
	2525 M08C	43,00 €	
	1616 H10C	39,00 €	
	2020 K10C	41,00 €	
	2525 M10C	43,00 €	
	3232 P10C	49,00 €	
	2020 K12C	41,00 €	
	2525 M12C	43,00 €	
3232 P12C	49,00 €		
 <p><b>SRHCR / L</b> RC.T 0803.. RC.T 10T3.. RC.T 1204.. RC.T 1606..</p> <p><b>R</b></p>	2525 K08	112,00 €	
	2525 K10	112,00 €	
	2525 K12	112,00 €	
	2525 K16	112,00 €	
 <p><b>SRXCR / L</b> RC.T 0803.. RC.T 10T3.. RC.T 1204..</p> <p><b>R</b></p>	3232 X08C	109,00 €	
	3232 X10C	109,00 €	
	3232 X12C	109,00 €	
 <p><b>SSDCN</b> SC.T 09T3.. SC.T 1204.. SC.T 1605..</p> <p><b>45°</b></p>	1212 F09	35,00 €	
	1616 H09-Z	35,00 €	
	1616 H09	39,00 €	
	2020 K09-Z	39,00 €	
	2020 K09	41,00 €	
	1616 H12-Z	35,00 €	
	1616 H12	39,00 €	
	2020 K12	41,00 €	
	2525 M12	43,00 €	
	2020 K16-Z	39,00 €	



S - SYSTEM EXTERNAL TURNING TOOLHOLDERS / AUßEN - DREHHALTER			PRICE / PREIS
 <p><b>SSSCR / L</b></p> <p>SC.T 09T3.. SC.T 1204..</p> <p>45°</p>	1212 F09	35,00 €	
	1616 H09-Z	35,00 €	
	1616 H09	39,00 €	
	2020 K09-Z	39,00 €	
	2020 K09	41,00 €	
	1616 H12	39,00 €	
	2020 K12-Z	39,00 €	
	2020 K12	41,00 €	
	2525 M12-Z	41,00 €	
	2525 M12	43,00 €	
 <p><b>STFCR / L</b></p> <p>TC.T 0902.. TC.T 1102.. TC.T 16T3..</p> <p>90°</p>	0808 E09	35,00 €	
	1010 E09	35,00 €	
	1212 F11	35,00 €	
	1616 H11	35,00 €	
	1616 H16	39,00 €	
	2020 K16	41,00 €	
	2525 M16	43,00 €	
	3232 P16	49,00 €	
	 <p><b>STGCR / L</b></p> <p>TC.T 0902.. TC.T 1102.. TC.T 16T3..</p> <p>90°</p>	0808 E09	35,00 €
1010 E09		35,00 €	
1212 F11		35,00 €	
1616 H11		35,00 €	
1616 H16		39,00 €	
2020 K16		41,00 €	
2525 M16		43,00 €	
3232 P16		49,00 €	
 <p><b>STJCR / L</b></p> <p>TC.T 0902.. TC.T 1102.. TC.T 16T3..</p> <p>93°</p>		0808 E09	35,00 €
	1010 E09	35,00 €	
	1212 F11	35,00 €	
	1616 H11	35,00 €	
	1616 H16	39,00 €	
	2020 K16	41,00 €	
	2525 M16	43,00 €	
	3232 P16	49,00 €	
	 <p><b>STCCN</b></p> <p>TC.T 1102.. TC.T 16T3.. TC.T 2204..</p> <p>90°</p>	2020 L11	66,00 €
1616 K16		61,00 €	
2020 M16		66,00 €	
2525 P16		71,00 €	
3232 R16		80,00 €	
2525 P22		71,00 €	
 <p><b>STUCR / L</b></p> <p>TC.T 0902.. TC.T 1102.. TC.T 16T3..</p> <p>93°</p>	0808 E09	35,00 €	
	1010 E09	35,00 €	
	1212 F11	35,00 €	
	1616 H11	35,00 €	
	2020 K16	41,00 €	
	2525 M16	43,00 €	
	3232 P16	49,00 €	







S - SYSTEM EXTERNAL TURNING TOOLHOLDERS / AUßEN - DREHHALTER			PRICE / PREIS
 <p><b>SVHBR / L</b> VBM. 1103.. VBM. 1604..</p> <p>107.5°</p>	1212 F11	35,00 €	
	1616 H11	35,00 €	
	2020 K11	39,00 €	
	2020 K16	41,00 €	
	2525 M16	43,00 €	
	3232 P16	49,00 €	
 <p><b>SVHCR / L</b> VC.T 1103.. VC.T 1604..</p> <p>107.5°</p>	1212 F11	35,00 €	
	1616 H11	35,00 €	
	2020 K11	39,00 €	
	2020 K16	41,00 €	
	2525 M16	43,00 €	
	3232 P16	49,00 €	
 <p><b>SVJBR / L</b> VBM. 1103.. VBM. 1604..</p> <p>93°</p>	1212 F11	35,00 €	
	1616 H11	35,00 €	
	2020 K11	39,00 €	
	1616 H16	39,00 €	
	2020 K16	41,00 €	
	2525 M16	43,00 €	
 <p><b>SVJCR / L</b> VC.T 1103.. VC.T 1604..</p> <p>93°</p>	1212 F11	35,00 €	
	1616 H11	35,00 €	
	2020 K11	39,00 €	
	1212 F16	35,00 €	
	2020 K16	41,00 €	
	2525 M16	43,00 €	
 <p><b>SVVBN</b> VBM. 1103.. VBM. 1604..</p> <p>72.5°</p>	1212 F11	35,00 €	
	1616 H11	35,00 €	
	2020 K11	39,00 €	
	2020 K16	41,00 €	
	2525 M16	43,00 €	
	3232 P16	49,00 €	
 <p><b>SVVCN</b> VC.T 1103.. VC.T 1604..</p> <p>72.5°</p>	1212 F11	35,00 €	
	1616 H11	35,00 €	
	2020 K11	39,00 €	
	2020 K16	41,00 €	
	2525 M16	43,00 €	
	3232 P16	49,00 €	
TOOLS FOR SWISS TYPE SLIDING AUTOMATIC LATHES / WERKZEUGE FÜR LANGDREHAUTOMATEN			PRICE / PREIS
 <p><b>SCACR / L</b> CC.T 0602.. CC.T 09T3..</p> <p>90°</p>	NEW 0808 X06-S	43,00 €	
	1010 K06-S	45,00 €	
	NEW 1212 G06-S	45,00 €	
	NEW 1212 K06-S	47,00 €	
	1212 K09-S	47,00 €	
	1616 K09-S	49,00 €	
	2020 K09-S	51,00 €	



TOOLS FOR SWISS TYPE SLIDING AUTOMATIC LATHES / WERKZEUGE FÜR LANGDREHAUTOMATEN		PRICE / PREIS
 <p><b>SCLCR / L</b> CC.T 0602.. CC.T 09T3..</p> <p>95°</p>	0808 X06-S	43,00 €
	1010 X06-S	43,00 €
	1212 G06-S	45,00 €
	1212 X06-S	45,00 €
	1616 F06-S	47,00 €
	1616 X06-S	47,00 €
	1212 G09-S	45,00 €
	1212 X09-S	45,00 €
	1616 F09-S	47,00 €
	NEW 1616 G09-S	47,00 €
	1616 X09-S	47,00 €
	2020 X09-S	49,00 €
 <p><b>SDACR / L</b> DC.T 0702.. DC.T 11T3..</p> <p>90°</p>	NEW 0808 X07-S	43,00 €
	1010 K07-S	45,00 €
	1212 K07-S	47,00 €
	1616 K07-S	49,00 €
	1212 K11-S	47,00 €
	NEW 1616 F11-S	47,00 €
	1616 K11-S	49,00 €
	2020 K11-S	51,00 €
 <p><b>SDJCR / L</b> DC.T 0702.. DC.T 11T3..</p> <p>93°</p>	0808 X07-S	43,00 €
	1010 X07-S	43,00 €
	1212 G07-S	45,00 €
	1212 X07-S	45,00 €
	1616 F07-S	47,00 €
	1616 X07-S	47,00 €
	2020 X07-S	49,00 €
	1212 G11-S	45,00 €
	1212 X11-S	45,00 €
	1212 K11-S	47,00 €
	1616 F11-S	47,00 €
	1616 X11-S	47,00 €
	1616 K11-S	49,00 €
	2020 X11-S	49,00 €
 <p><b>STGCR / L</b> TC.T 1102.. TC.T 16T3..</p> <p>91°</p>	1216 K11-S	49,00 €
	1616 K11-S	49,00 €
	1216 K16-S	49,00 €
	1616 K16-S	49,00 €
 <p><b>SVACR / L</b> VC.T 1103.. VC.T 1604..</p> <p>90°</p>	1010 K11-S	45,00 €
	1212 K11-S	47,00 €
	1616 K11-S	49,00 €
	2020 K11-S	51,00 €
	NEW 1212 K16-S	47,00 €
	NEW 1616 K16-S	49,00 €

TOOLS FOR SWISS TYPE SLIDING AUTOMATIC LATHES / WERKZEUGE FÜR LANGDREHAUTOMATEN		PRICE / PREIS
 <p><b>SVJBR / L</b> VBM. 1103..</p> <p>93°</p>	1616 K11-S	49,00 €
 <p><b>SVJCR / L</b> VC.T 1103..</p> <p>93°</p>	0808 X11-S	43,00 €
	1212 K11-S	47,00 €

T - SYSTEM BORING BARS / BOHRSTANGE T-SYSTEM		PRICE / PREIS
 <p><b>TCLNR / L</b> CNM. 0903.. CNM. 1204.. CNM. 1606..</p> <p>95°</p>	S25S TCLNR / L 09-Z	66,00 €
	S25S TCLNR / L 09	69,00 €
	S25S TCLNR / L 12-Z	66,00 €
	S25S TCLNR / L 12	69,00 €
	S32T TCLNR / L 12	85,00 €
	S40U TCLNR / L 12	112,00 €
	S50V TCLNR / L 12	135,00 €
	S32T TCLNR / L 16	88,00 €
	S40U TCLNR / L 16	118,00 €
	S50V TCLNR / L 16	142,00 €
 <p><b>TD-NR / L</b> DNM. 1506..</p> <p>62.5°</p>	S32T TD-NR / L 15	85,00 €
	S40U TD-NR / L 15	112,00 €
	S50V TD-NR / L 15	135,00 €
 <p><b>TDQNR / L</b> DNM. 1104.. DNM. 1506..</p> <p>107.5°</p>	S25S TDQNR / L 11-Z	66,00 €
	S25S TDQNR / L 11	69,00 €
	S32T TDQNR / L 11	85,00 €
	<small>NEW</small> S25S TDQNR / L 15	69,00 €
	S32T TDQNR / L 15	85,00 €
	S40U TDQNR / L 15	112,00 €
	S50V TDQNR / L 15	135,00 €

T - SYSTEM BORING BARS / BOHRSTANGE T-SYSTEM			PRICE / PREIS
 <p><b>TDUNR / L</b> DNM. 1104.. DNM. 1506..</p> <p>93°</p>	S25S TDUNR / L 11-Z	66,00 €	
	S25S TDUNR / L 11	69,00 €	
	S32T TDUNR / L 11	85,00 €	
	S25S TDUNR / L 15	69,00 €	
	S32T TDUNR / L 15	85,00 €	
	S40U TDUNR / L 15	112,00 €	
	S50V TDUNR / L 15	135,00 €	
 <p><b>TSKNR / L</b> SNM. 1204..</p> <p>75°</p>	S25S TSKNR / L 12-Z	66,00 €	
	S25S TSKNR / L 12	69,00 €	
	S32T TSKNR / L 12	85,00 €	
	S40U TSKNR / L 12	112,00 €	
 <p><b>TT-NR / L</b> TNM. 1604..</p> <p>60°</p>	S25S TT-NR / L 16-Z	66,00 €	
	S25S TT-NR / L 16	69,00 €	
	S32T TT-NR / L 16	85,00 €	
 <p><b>TTUNR / L</b> TNM. 1604.. TNM. 2204..</p> <p>93°</p>	S25S TTUNR / L 16-Z	66,00 €	
	S25S TTUNR / L 16	69,00 €	
	S32T TTUNR / L 16	85,00 €	
	S25S TTUNR / L 22	69,00 €	
	S32T TTUNR / L 22	85,00 €	
	S40U TTUNR / L 22	112,00 €	
	S50V TTUNR / L 22	135,00 €	
 <p><b>TVUNR / L</b> VNM. 1604..</p> <p>93°</p>	S25S TVUNR / L 16	69,00 €	
	S32T TVUNR / L 16	85,00 €	
	S40U TVUNR / L 16	112,00 €	
 <p><b>TWLNR / L</b> WNM. 0604.. WNM. 0804..</p> <p>95°</p>	S25S TWLNR / L 06-Z	66,00 €	
	S25S TWLNR / L 06	69,00 €	
	S32T TWLNR / L 06	85,00 €	
	S25S TWLNR / L 08-Z	66,00 €	
	S25S TWLNR / L 08	69,00 €	
	S32T TWLNR / L 08	85,00 €	
	S40U TWLNR / L 08	112,00 €	
	S50V TWLNR / L 08	135,00 €	

S25S TT-NR 16, "S": Steel Shank / Ohne Innenkühlung  
S25S TT-NR 16-Z, "-Z": Without Shim / Ohne Unterlegplatte

Ordering Example/Beispiel Bestellformular: 1pcs. S25S TDUNR 11-Z

C - SYSTEM BORING BARS / BOHRSTANGE C-SYSTEM			PRICE / PREIS
 <p><b>CKUNR / L</b> <b>KNUX 1604..</b></p> <p>93°</p>	S25S CKUNR / L 16	69,00 €	
	S32T CKUNR / L 16	85,00 €	
	S40U CKUNR / L 16	112,00 €	
	S50V CKUNR / L 16	135,00 €	



M - SYSTEM BORING BARS / BOHRSTANGE M-SYSTEM			PRICE / PREIS
 <p><b>MCLNR / L</b> <b>CNM. 1204..</b></p> <p>95°</p>	S20R MCLNR / L 12	59,00 €	
	S25S MCLNR / L 12-Z	66,00 €	
	S25S MCLNR / L 12	69,00 €	
	S32T MCLNR / L 12	85,00 €	

 <p><b>MDUNR / L</b> <b>DNM. 1104..</b> <b>DNM. 1506..</b></p> <p>93°</p>	S20R MDUNR / L 11	59,00 €
	S25S MDUNR / L 11	66,00 €
	S25S MDUNR / L 15-Z	66,00 €
	S25S MDUNR / L 15	69,00 €
	S32T MDUNR / L 15	85,00 €
	S40U MDUNR / L 15	112,00 €
	S50V MDUNR / L 15	135,00 €

 <p><b>MTFNR / L</b> <b>TNM. 1604..</b> <b>TNM. 2204..</b></p> <p>90°</p>	S20R MTFNR / L 16	59,00 €
	S25S MTFNR / L 16	69,00 €
	S32T MTFNR / L 16	85,00 €
	S40U MTFNR / L 16	112,00 €
	S32T MTFNR / L 22	85,00 €
	S40U MTFNR / L 22	112,00 €
	<small>NEW</small> S50V MTFNR / L 22	135,00 €

 <p><b>MT-NR / L</b> <b>TNM. 1604..</b> <b>TNM. 2204..</b></p> <p>60°</p>	S20R MT-NR / L 16	59,00 €
	S25S MT-NR / L 16-Z	66,00 €
	S25S MT-NR / L 16	69,00 €
	S32T MT-NR / L 16	85,00 €
	S40U MT-NR / L 16	85,00 €
	S32T MT-NR / L 22	112,00 €
	S40U MT-NR / L 22	112,00 €
	S50U MT-NR / L 22	135,00 €





 <p><b>MTQNR / L</b> <b>TNM. 1604..</b> <b>TNM. 2204..</b></p> <p>107.5°</p>	S20R MTQNR / L 16	59,00 €
	S25S MTQNR / L 16-Z	66,00 €
	S25S MTQNR / L 16	69,00 €
	S32T MTQNR / L 16	85,00 €
	S40U MTQNR / L 16	112,00 €
	S32T MTQNR / L 22	85,00 €
	S40U MTQNR / L 22	112,00 €
	S50V MTQNR / L 22	135,00 €

M - SYSTEM BORING BARS / BOHRSTANGE M-SYSTEM		PRICE / PREIS
 <p><b>MTUNR / L</b> TNM. 1604.. TNM. 2204..</p> <p>93°</p>	S20R MTUNR / L 16	59,00 €
	S25S MTUNR / L 16-Z	66,00 €
	S25S MTUNR / L 16	69,00 €
	S32T MTUNR / L 16	85,00 €
	S40U MTUNR / L 16	112,00 €
	S50V MTUNR / L 16	135,00 €
	S32T MTUNR / L 22	85,00 €
	S40U MTUNR / L 22	112,00 €
	S50V MTUNR / L 22	135,00 €
 <p><b>MWLNR / L</b> WNM. 0604.. WNM. 0804..</p> <p>95°</p>	S16P MWLNR / L 06	57,00 €
	S20R MWLNR / L 06	59,00 €
	S25S MWLNR / L 06	66,00 €
	S25S MWLNR / L 08-Z	66,00 €
	S25S MWLNR / L 08	69,00 €
	S32T MWLNR / L 08	85,00 €
	S40U MWLNR / L 08	112,00 €

P - SYSTEM BORING BARS / BOHRSTANGE P-SYSTEM		PRICE / PREIS
 <p><b>PCLNR / L</b> CNM. 0903.. CNM. 1204.. CNM. 1606.. CNM. 1906..</p> <p>95°</p>	S16P PCLNR / L 09	57,00 €
	S20R PCLNR / L 09	59,00 €
	S25S PCLNR / L 12C	69,00 €
	S32T PCLNR / L 12C	85,00 €
	S40U PCLNR / L 12C	112,00 €
	S50V PCLNR / L 12C	135,00 €
	S32T PCLNR / L 16C	88,00 €
	S40U PCLNR / L 16C	118,00 €
	S50V PCLNR / L 16C	142,00 €
	S40U PCLNR / L 19C	147,00 €
	S50V PCLNR / L 19C	171,00 €
	A25R PCLNR / L 12C	85,00 €
	A32S PCLNR / L 12C	102,00 €
	A40T PCLNR / L 12C	135,00 €
	A50U PCLNR / L 12C	163,00 €
	A32S PCLNR / L 16C	106,00 €
	A40T PCLNR / L 16C	142,00 €
	A50U PCLNR / L 16C	171,00 €
	A40T PCLNR / L 19C	184,00 €
	A50U PCLNR / L 19C	204,00 €

S25S MTUNR 16-Z, "-Z": Without Shim / Ohne Unterlegplatte  
 S25S PCLNR 12, "S": Steel Shank / Ohne Innenkühlung  
 A25R PCLNR 12, "A": Solid Steel With Coolant Hole / Mit Innenkühlung

Ordering Example/Beispiel Bestellformular: 1pcs. S20R MTUNR 16



P - SYSTEM BORING BARS / BOHRSTANGE P-SYSTEM			PRICE / PREIS
 <p><b>PDQNR / L</b></p> <p><b>DNM. 1104..</b> <b>DNM. 1504..</b> <b>DNM. 1506..</b></p> <p><b>107.5°</b></p>	S25S PDQNR / L 11	69,00 €	
	S32T PDQNR / L 15	85,00 €	
	S40U PDQNR / L 15	112,00 €	
	S50V PDQNR / L 15	135,00 €	
	S32T PDQNR / L 1504	85,00 €	
	S40U PDQNR / L 1504	112,00 €	
	S50V PDQNR / L 1504	135,00 €	
	A20P PDQNR / L 11	70,00 €	
	A25R PDQNR / L 11	85,00 €	
	A32S PDQNR / L 15	102,00 €	
	A40T PDQNR / L 15	135,00 €	
	A50U PDQNR / L 15	163,00 €	
	A32S PDQNR / L 1504	102,00 €	
	A40T PDQNR / L 1504	135,00 €	
 <p><b>PDUNR / L</b></p> <p><b>DNM. 1104..</b> <b>DNM. 1506..</b></p> <p><b>93°</b></p>	S20R PDUNR / L 11	59,00 €	
	S25S PDUNR / L 11	69,00 €	
	S25S PDUNR / L 15	69,00 €	
	S32T PDUNR / L 15	85,00 €	
	S40U PDUNR / L 15	112,00 €	
	S50V PDUNR / L 15	135,00 €	
	A20P PDUNR / L 11	70,00 €	
	<small>NEW</small> A25R PDUNR / L 11	85,00 €	
	A32S PDUNR / L 11	102,00 €	
	A32S PDUNR / L 15	102,00 €	
	A40T PDUNR / L 15	135,00 €	
	A50U PDUNR / L 15	163,00 €	
 <p><b>PDXNR / L</b></p> <p><b>DNM. 1506..</b></p> <p><b>93°</b></p>	S32T PDXNR / L 15	85,00 €	
	S40U PDXNR / L 15	112,00 €	
	S50V PDXNR / L 15	135,00 €	
 <p><b>PSKNR / L</b></p> <p><b>SNM. 1204..</b></p> <p><b>75°</b></p>	S25S PSKNR / L 12C	69,00 €	
	S32T PSKNR / L 12C	85,00 €	
	S40U PSKNR / L 12C	112,00 €	
	S50V PSKNR / L 12C	135,00 €	
 <p><b>PTUNR / L</b></p> <p><b>TNM. 1604..</b> <b>TNM. 2204..</b></p> <p><b>93°</b></p>	S16P PTUNR / L 16	57,00 €	
	S20R PTUNR / L 16	59,00 €	
	S25S PTUNR / L 16C	69,00 €	
	S32T PTUNR / L 16C	85,00 €	
	S40U PTUNR / L 16C	112,00 €	
	S32T PTUNR / L 22C	85,00 €	
	S40U PTUNR / L 22C	112,00 €	
	S50V PTUNR / L 22C	135,00 €	

P - SYSTEM BORING BARS / BOHRSTANGE P-SYSTEM		PRICE / PREIS
 <p><b>PWLNR / L</b> <b>WNM. 0604..</b> <b>WNM. 0804..</b></p> <p><b>95°</b></p>	S20R PWLNR / L 06	59,00 €
	S25S PWLNR / L 06	69,00 €
	S32T PWLNR / L 06	85,00 €
	S25S PWLNR / L 08C	69,00 €
	S32T PWLNR / L 08C	85,00 €
	S40U PWLNR / L 08C	112,00 €
	S50V PWLNR / L 08C	135,00 €
	A20P PWLNR / L 06	70,00 €
	A25R PWLNR / L 06	85,00 €
	A32S PWLNR / L 06	102,00 €
	A25R PWLNR / L 08C	85,00 €
	A32S PWLNR / L 08C	102,00 €
	A40T PWLNR / L 08C	135,00 €
	A50U PWLNR / L 08C	163,00 €



S25S PWLNR 08, "S": Steel Shank / Ohne Innenkühlung  
A25R PWLNR 08, "A": Solid Steel With Coolant Hole / Mit Innenkühlung

Ordering Example/Beispiel Bestellformular: 1pcs. S20R PWLNR 06



S - SYSTEM BORING BARS / BOHRSTANGE S-SYSTEM			PRICE / PREIS
 <p><b>SCFCR / L</b></p> <p>CC.T 0602.. CC.T 09T3..</p> <p><b>90°</b></p>		S08H SCFCR / L 06	24,00 €
		S10K SCFCR / L 06	27,00 €
		S12K SCFCR / L 06	29,00 €
		S12K SCFCR / L 09	29,00 €
		S16P SCFCR / L 09	34,00 €
		S20R SCFCR / L 09	35,00 €
		S25S SCFCR / L 09-Z	45,00 €
		S25S SCFCR / L 09	47,00 €
 <p><b>SCLCR / L</b></p> <p>CC.T 0301.. CC.T 0602.. CC.T 09T3.. CC.T 1204..</p> <p><b>95°</b></p>		S0608H SCLCR / L 03	44,00 €
		S0608H SCLCR / L 06	24,00 €
		S08H SCLCR / L 06	24,00 €
		S10K SCLCR / L 06	27,00 €
		S12K SCLCR / L 06	29,00 €
		S1216P SCLCR / L 06	34,00 €
		S16P SCLCR / L 06	34,00 €
		S12K SCLCR / L 09	29,00 €
		S1416P SCLCR / L 09	34,00 €
		S16P SCLCR / L 09	34,00 €
		S1620R SCLCR / L 09	35,00 €
		S20R SCLCR / L 09	35,00 €
		S25S SCLCR / L 09-Z	45,00 €
		S25S SCLCR / L 09	47,00 €
		S32T SCLCR / L 09	72,00 €
		S25S SCLCR / L 12-Z	45,00 €
		S25S SCLCR / L 12	47,00 €
		S32T SCLCR / L 12	72,00 €
		S40U SCLCR / L 12	107,00 €
		A08H SCLCR / L 06	29,00 €
		A10H SCLCR / L 06	33,00 €
		A12H SCLCR / L 06	35,00 €
		A16M SCLCR / L 09	42,00 €
		A20P SCLCR / L 09	43,00 €
	A25R SCLCR / L 09	60,00 €	
	A32S SCLCR / L 09	92,00 €	
	A25R SCLCR / L 12	60,00 €	
 <p><b>SD-CR / L</b></p> <p>DC.T 0702.. DC.T 11T3..</p> <p><b>62.5°</b></p>		<small>NEW</small> S10K SD-CR / L 07	27,00 €
		S12K SD-CR / L 07	29,00 €
		<small>NEW</small> S16P SD-CR / L 07	34,00 €
		S16P SD-CR / L 11	34,00 €
		<small>NEW</small> S20R SD-CR / L 07	35,00 €
		S20R SD-CR / L 11	35,00 €
		S25S SD-CR / L 11-Z	45,00 €
		S25S SD-CR / L 11	47,00 €
		S32T SD-CR / L 11	72,00 €
		S40U SD-CR / L 11	107,00 €



S - SYSTEM BORING BARS / BOHRSTANGE S-SYSTEM			PRICE / PREIS
 <p><b>SDPCR / L</b> DC.T 0702.. DC.T 11T3.. <b>117.5°</b></p>	S10K SDPCR / L 07	27,00 €	
	S12K SDPCR / L 07	29,00 €	
	S16P SDPCR / L 11	34,00 €	
	S20R SDPCR / L 11	35,00 €	
	S25S SDPCR / L 11	47,00 €	
 <p><b>SDQCR / L</b> DC.T 0702.. DC.T 11T3.. <b>107.5°</b></p>	S10K SDQCR / L 07	27,00 €	
	S12K SDQCR / L 07	29,00 €	
	S16P SDQCR / L 07	34,00 €	
	S20R SDQCR / L 07	35,00 €	
	S16P SDQCR / L 11	34,00 €	
	S20R SDQCR / L 11	35,00 €	
	S25S SDQCR / L 11-Z	45,00 €	
	S25S SDQCR / L 11	47,00 €	
	S32T SDQCR / L 11	72,00 €	
	<small>NEW</small> S40U SDQCR / L 11	107,00 €	
	A10H SDQCR / L 07	33,00 €	
	A12H SDQCR / L 07	35,00 €	
	A16M SDQCR / L 07	42,00 €	
	A20P SDQCR / L 07	43,00 €	
	A16M SDQCR / L 11	42,00 €	
	A20P SDQCR / L 11	43,00 €	
	A25R SDQCR / L 11	60,00 €	
A32S SDQCR / L 11	92,00 €		
 <p><b>SDUCR / L</b> DC.T 0702.. DC.T 11T3.. <b>93°</b></p>	S0810K SDUCR / L 07	28,00 €	
	S10K SDUCR / L 07	27,00 €	
	S12K SDUCR / L 07	29,00 €	
	S1216P SDUCR / L 07	34,00 €	
	S1416P SDUCR / L 07	34,00 €	
	S16P SDUCR / L 07	34,00 €	
	S20R SDUCR / L 07	35,00 €	
	S1416P SDUCR / L 11	34,00 €	
	S16P SDUCR / L 11	34,00 €	
	S1620R SDUCR / L 11	35,00 €	
	S20R SDUCR / L 11	35,00 €	
	S25S SDUCR / L 11-Z	45,00 €	
	S25S SDUCR / L 11	47,00 €	
	S32T SDUCR / L 11	72,00 €	
	S40U SDUCR / L 11	107,00 €	
	S50V SDUCR / L 11	129,00 €	
	A0810H SDUCR / L 07	33,00 €	
	A10H SDUCR / L 07	33,00 €	
	A12H SDUCR / L 07	35,00 €	
	A16M SDUCR / L 07	42,00 €	
	A20P SDUCR / L 07	43,00 €	
	A16M SDUCR / L 11	42,00 €	
	A20P SDUCR / L 11	43,00 €	
A25R SDUCR / L 11	60,00 €		
A32S SDUCR / L 11	92,00 €		







S25S SDQCR 11-Z, "-Z": Without Shim / Ohne Unterlegplatte / S25S SDQCR 11, "S": Steel Shank / Ohne Innenkühlung  
A25R SDQCR 11, "A": Solid Steel With Coolant Hole / Mit Innenkühlung

Ordering Example/Beispiel Bestellformular: 1pcs. S10K SDPCR 07







S - SYSTEM BORING BARS / BOHRSTANGE S-SYSTEM			PRICE / PREIS
 <p><b>SDXCR / L</b></p> <p>DC.T 0702.. DC.T 11T3..</p> <p>93°</p>	S12K SDXCR / L 07	29,00 €	
	S16P SDXCR / L 07	34,00 €	
	S20R SDXCR / L 11	35,00 €	
	S25S SDXCR / L 11-Z	45,00 €	
	S25S SDXCR / L 11	47,00 €	
	S32T SDXCR / L 11	72,00 €	
	S40U SDXCR / L 11	107,00 €	
 <p><b>SRGCR / L</b></p> <p>RC.T 0803..</p> <p>NEW</p> <p>1°</p>	S16P SRGCR / L 08	68,00 €	
	S20R SRGCR / L 08	72,00 €	
	S25S SRGCR / L 08C	98,00 €	
	S32T SRGCR / L 08C	141,00 €	
	S40U SRGCR / L 08C	206,00 €	
 <p><b>SSSCR / L</b></p> <p>SC.T 09T3.. SC.T 1204..</p> <p>45°</p>	S16P SSSCR / L 09	34,00 €	
	S20R SSSCR / L 09	35,00 €	
	<small>NEW</small> S25S SSSCR / L 09	47,00 €	
	S25S SSSCR / L 09-Z	45,00 €	
	S25S SSSCR / L 12	47,00 €	
	S32T SSSCR / L 12	72,00 €	
	S40U SSSCR / L 12	107,00 €	
 <p><b>ST-CR / L</b></p> <p>TC.T 1102.. TC.T 16T3..</p> <p>60°</p>	S12K ST-CR / L 11	29,00 €	
	S16P ST-CR / L 11	34,00 €	
	<small>NEW</small> S20R ST-CR / L 11	35,00 €	
	S16P ST-CR / L 16	34,00 €	
	S20R ST-CR / L 16	35,00 €	
	S25S ST-CR / L 16-Z	45,00 €	
	S25S ST-CR / L 16	47,00 €	
	S32T ST-CR / L 16	72,00 €	
	S40U ST-CR / L 16	107,00 €	
 <p><b>STFCR / L</b></p> <p>TC.T 06T1.. TC.T 0902.. TC.T 1102.. TC.T 16T3..</p> <p>90°</p>	S0610F STFCR / L 06	35,00 €	
	S08H STFCR / L 06	24,00 €	
	S10K STFCR / L 09	27,00 €	
	S12K STFCR / L 09	29,00 €	
	S12K STFCR / L 11	29,00 €	
	S16P STFCR / L 11	34,00 €	
	S20R STFCR / L 11	35,00 €	
	S16P STFCR / L 16	34,00 €	
	S20R STFCR / L 16	35,00 €	
	S25S STFCR / L 16-Z	45,00 €	
	S25S STFCR / L 16	47,00 €	
	S32T STFCR / L 16	72,00 €	

S - SYSTEM BORING BARS / BOHRSTANGE S-SYSTEM			PRICE / PREIS
 <p><b>STUCR / L</b></p> <p>TC.T 0902.. TC.T 1102.. TC.T 16T3..</p> <p>93°</p>	<p>S10K STUCR / L 09</p> <p>S12K STUCR / L 09</p> <p>S12K STUCR / L 11</p> <p>S16P STUCR / L 11</p> <p>S20R STUCR / L 11</p> <p>S16P STUCR / L 16</p> <p>S20R STUCR / L 16</p> <p>S25S STUCR / L 16-Z</p> <p>S25S STUCR / L 16</p> <p>S32T STUCR / L 16</p> <p>S40U STUCR / L 16</p>	27,00 €	
		29,00 €	
		29,00 €	
		34,00 €	
		35,00 €	
		34,00 €	
		35,00 €	
		45,00 €	
		47,00 €	
		72,00 €	
		107,00 €	
 <p><b>STUPR / L</b></p> <p>TP.. 0802.. TP.. 1103..</p> <p>93°</p>	<p>S08H STUPR / L 0802</p> <p>S10K STUPR / L 1103</p> <p>S12K STUPR / L 1103</p> <p>S12M STUPR / L 1103</p> <p>S16P STUPR / L 1103</p> <p>S16R STUPR / L 1103</p>	31,00 €	
		33,00 €	
		35,00 €	
		40,00 €	
		41,00 €	
		49,00 €	
 <p><b>SVJBR / L</b></p> <p>VBM. 1604..</p> <p>93°</p>	<p>S25S SVJBR / L 16</p> <p>S32T SVJBR / L 16</p> <p>S40U SVJBR / L 16</p>	57,00 €	
		72,00 €	
		107,00 €	
 <p><b>SVQBR / L</b></p> <p>VBM. 1103.. VBM. 1604..</p> <p>107.5°</p>	<p>S16P SVQBR / L 11</p> <p>S20R SVQBR / L 11</p> <p>S25S SVQBR / L 16-Z</p> <p>S25S SVQBR / L 16</p> <p>S32T SVQBR / L 16</p> <p>S40U SVQBR / L 16</p>	34,00 €	
		35,00 €	
		54,00 €	
		57,00 €	
		72,00 €	
		107,00 €	
 <p><b>SVQCR / L</b></p> <p>VC.T 1103.. VC.T 1604..</p> <p>107.5°</p>	<p>S16P SVQCR / L 11</p> <p>S20R SVQCR / L 11</p> <p>S25S SVQCR / L 16-Z</p> <p>S25S SVQCR / L 16</p> <p>S32T SVQCR / L 16</p> <p>S40U SVQCR / L 16</p>	34,00 €	
		35,00 €	
		54,00 €	
		57,00 €	
		72,00 €	
		107,00 €	

S - SYSTEM BORING BARS / BOHRSTANGE S-SYSTEM			PRICE / PREIS
 <p><b>SVUBR / L</b> VBM. 1103.. VBM. 1604..</p> <p>93°</p>	S16P SVUBR / L 11	34,00 €	
	S20R SVUBR / L 11	35,00 €	
	S25S SVUBR / L 16-Z	54,00 €	
	S25S SVUBR / L 16	57,00 €	
	S32T SVUBR / L 16	72,00 €	
	S40U SVUBR / L 16	107,00 €	
 <p><b>SVUCR / L</b> VC.T 1103.. VC.T 1604..</p> <p>93°</p>	S16P SVUCR / L 11	34,00 €	
	S20R SVUCR / L 11	35,00 €	
	S25S SVUCR / L 16-Z	54,00 €	
	S25S SVUCR / L 16	57,00 €	
	S32T SVUCR / L 16	72,00 €	
	S40U SVUCR / L 16	107,00 €	
 <p><b>SVXBR / L</b> VBM. 1102.. VBM. 1103.. VBM. 1604..</p> <p>93°</p>	<sup>NEW</sup> S16P SVXBR / L 1102	52,00 €	
	<sup>NEW</sup> S20R SVXBR / L 1102	54,00 €	
	S16P SVXBR / L 11	34,00 €	
	S20R SVXBR / L 11	35,00 €	
	S25S SVXBR / L 16	57,00 €	
	S32T SVXBR / L 16	72,00 €	
	S40U SVXBR / L 16	107,00 €	
 <p><b>SVJCR / L</b> VC.T 1103..</p> <p>93°</p>	S12K SVJCR / L 11	35,00 €	
	S16P SVJCR / L 11	41,00 €	
	S20R SVJCR / L 11	42,00 €	
 <p><b>SWLCR</b> WC.. 0302..</p> <p>95°</p>	S0608H SWLCR 03	24,00 €	
	S0810K SWLCR 03	27,00 €	
 <p><b>SWUBR</b> WBGT 060102-L</p> <p>93°</p>	S08H SWUBR 06-5.5	32,00 €	
	S08H SWUBR 06-7	32,00 €	
	<sup>NEW</sup> S0610H SWUBR 06	40,00 €	
S-SYSTEM BORING BARS WITH CARBIDE SHANK / BOHRSTANGE MIT VOLLHARTMETALLSCHAFT			PRICE / PREIS
 <p><b>SCLCR / L</b> CC.T 0602.. CC.T 09T3..</p> <p>95°</p>	E08K SCLCR / L 06	161,00 €	
	E10M SCLCR / L 06	216,00 €	
	E12Q SCLCR / L 06	268,00 €	
	E16R SCLCR / L 09	321,00 €	
	E20S SCLCR / L 09	612,00 €	

S-SYSTEM BORING BARS WITH CARBIDE SHANK / BOHRSTANGE MIT VOLLHARTMETALLSCHAFT			PRICE / PREIS
 <p><b>NEW</b></p> <p><b>SDUCR / L</b></p> <p>DC.T 0702.. DC.T 11T3..</p> <p>93°</p>	E10M SDUCR / L 07	216,00 €	
	E12Q SDUCR / L 07	268,00 €	
	E16R SDUCR / L 11	321,00 €	
	E20S SDUCR / L 11	612,00 €	
S-SYSTEM BORING BARS SETS / BOHRSTANGEN-SET S-SYSTEM			PRICE / PREIS
 <p><b>NEW</b></p> <p><b>SET-A/SCLCR / L</b></p> <p>CC.T 0602.. CC.T 09T3..</p> <p>95°</p>	A08H SCLCR / L 06	168,00 €	
	A10H SCLCR / L 06		
	A12H SCLCR / L 06		
	A16M SCLCR / L 09		
 <p><b>NEW</b></p> <p><b>SET-E/SCLCR / L</b></p> <p>CC.T 0602.. CC.T 09T3..</p> <p>95°</p>	E08K SCLCR / L 06	998,00 €	
	E10M SCLCR / L 06		
	E12Q SCLCR / L 06		
	E16R SCLCR / L 09		
 <p><b>NEW</b></p> <p><b>SET-S/SCLCR / L</b></p> <p>CC.T 0602.. CC.T 09T3..</p> <p>95°</p>	S08H SCLCR / L 06	144,00 €	
	S10K SCLCR / L 06		
	S12K SCLCR / L 06		
	S16P SCLCR / L 09		
 <p><b>NEW</b></p> <p><b>SET-A/SDUCR / L</b></p> <p>DC.T 0702.. DC.T 11T3..</p> <p>93°</p>	A10H SDUCR / L 07	140,00 €	
	A12H SDUCR / L 07		
	A16M SDUCR / L 11		
 <p><b>NEW</b></p> <p><b>SET-E/SDUCR / L</b></p> <p>DC.T 0702.. DC.T 11T3..</p> <p>93°</p>	E10M SDUCR / L 07	836,00 €	
	E12Q SDUCR / L 07		
	E16R SDUCR / L 11		
 <p><b>NEW</b></p> <p><b>SET-S/SDUCR / L</b></p> <p>DC.T 0702.. DC.T 11T3..</p> <p>93°</p>	S10K SDUCR / L 07	119,00 €	
	S12K SDUCR / L 07		
	S16P SDUCR / L 11		

CARTRIDGE / KURZDREHHALTER		PRICE / PREIS
 <p><b>SCACR / L</b></p> <p>CC.T 0602.. CC.T 09T3.. CC.T 1204..</p> <p>90°</p>	S10X SCACR / L 06	35,00 €
	S10A SCACR / L 06	35,00 €
	S10C SCACR / L 06	35,00 €
	S12B SCACR / L 06	37,00 €
	S12D SCACR / L 06	43,00 €
	NEW S12D SCACR / L 09	43,00 €
	NEW S12H SCACR / L 09	43,00 €
	S15C SCACR / L 09	43,00 €
	S15E SCACR / L 09	43,00 €
	S15D SCACR / L 09	43,00 €
	S16A SCACR / L 09	43,00 €
	S16B SCACR / L 09	43,00 €
	S16C SCACR / L 09	43,00 €
	S16D SCACR / L 09	43,00 €
	S16E SCACR / L 09	43,00 €
	S16G SCACR / L 09	43,00 €
	S16H SCACR / L 09	43,00 €
S18E SCACR / L 09	46,00 €	
S20E SCACR / L 09	46,00 €	
S20E SCACR / L 12	46,00 €	
S20H SCACR / L 12	46,00 €	
 <p><b>SCMCN</b></p> <p>CC.T 0602.. CC.T 09T3..</p> <p>50°</p>	S10X SCMCN 06	35,00 €
	S16C SCMCN 09	43,00 €
	S16D SCMCN 09	43,00 €
 <p><b>STXCR / L</b></p> <p>TC.T 16T3..</p> <p>1°</p>	STXCR / L 2020 B16	57,00 €
	STXCR / L 2020 E16	57,00 €
	STXCR / L 2020 B16-SA	57,00 €
	STXCR / L 2020 E16-SA	57,00 €
	NEW STXCR / L 2020 B16-PL	57,00 €
	NEW STXCR / L 2020 E16-PL	57,00 €
	NEW STXCR / L 2020 H16-PL	57,00 €
 <p><b>CTFPR / L</b></p> <p>TP.. 16 TP.. 22</p> <p>90°</p>	CTFPR / L 13CS 16	64,00 €
	CTFPR / L 15CS 22	64,00 €
 <p><b>CTSPR / L</b></p> <p>TP.. 11</p> <p>45°</p>	CTSPR / L 11.5CS 11	64,00 €

CARTRIDGE / KURZDREHHALTER			PRICE / PREIS
 <p><b>MSYNR / L</b> SNM. 1204..</p> <p>95°</p>	MSYNR / L 11.5CS 12	64,00 €	
	MSYNR / L 16CS 12	64,00 €	
 <p><b>SCFCR / L</b> CC.T 0602.. CC.T 09T3.. CC.T 1204..</p> <p>90°</p>	SCFCR / L 06CA 06	45,00 €	
	SCFCR / L 08CA 06	45,00 €	
	SCFCR / L 10CA 09	45,00 €	
	SCFCR / L 12CA 12	45,00 €	
	SCFCR / L 16CA 12	50,00 €	
 <p><b>SCSCR / L</b> CC.T 0602.. CC.T 09T3.. CC.T 1204..</p> <p>45°</p>	SCSCR / L 06CA 06	45,00 €	
	SCSCR / L 10CA 09	45,00 €	
	SCSCR / L 12CA 12	45,00 €	
 <p><b>SSKCR / L</b> SC.T 09T3..</p> <p>75°</p>	NEW SSKCR / L 10CA 09	45,00 €	
 <p><b>STFCR / L</b> TC.T 0902.. TC.T 1102.. TC.T 16T3..</p> <p>90°</p>	NEW STFCR / L 08CA 09	45,00 €	
	STFCR / L 10CA 11	45,00 €	
	STFCR / L 12CA 16	45,00 €	
	NEW STFCR / L 16CA 16	50,00 €	
 <p><b>STSCR / L</b> TC.T 0902.. TC.T 1102.. TC.T 16T3..</p> <p>45°</p>	STSCR / L 08CA 09	45,00 €	
	STSCR / L 10CA 11	45,00 €	
	STSCR / L 12CA 16	45,00 €	
 <p><b>STTCR / L</b> TC.T 0902.. TC.T 1102..</p> <p>60°</p>	STTCR / L 08CA 09	45,00 €	
	STTCR / L 10CA 11	45,00 €	

CARTRIDGE / KURZDREHHALTER			PRICE / PREIS	
 <p><b>NEW</b></p> <p>75°</p>	<b>PSKNR / L</b> <hr/> <b>SNM. 120408</b>	PSKNR / L 16CA 12	71,00 €	
 <p><b>NEW</b></p> <p>75°</p>	<b>PSRNR / L</b> <hr/> <b>SNM. 120408</b>	PSRNR / L 16CA 12	71,00 €	
 <p><b>NEW</b></p> <p>90°</p>	<b>PTFNR / L</b> <hr/> <b>TNM. 160408</b>	PTFNR / L 12CA 16	68,00 €	
 <p>45°</p>	<b>PSDNN 12</b> <hr/> <b>SNM. 1204..</b>	S22D PSDNN 12C	112,00 €	
PIPE BEVELING AND CHAMFERING TOOLS / ROHRENDENANFASWERKZEUG			PRICE / PREIS	
 <p><b>NEW</b></p>	<b>ACPBT</b> <hr/>	ACPBT-1	470,00 €	
			ACPBT-2	470,00 €
			ACPBT-3	470,00 €
			ACPBT-4	470,00 €
			ACPBT-5	470,00 €
			ACPBT-6	470,00 €
			ACPBT-7	470,00 €
			ACPBT-8	470,00 €
 <p><b>NEW</b></p>	<b>ACPBT</b> <hr/>	ACPBT-9	470,00 €	
			ACPBT-10	470,00 €









PIPE BEVELING AND CHAMFERING TOOLS BODY / TRÄGER ROHRENDENANFASWERKZEUG		PRICE / PREIS		
	ÖTG	ÖTG-K-120-20 _____ _____ _____ _____	280,00 €	
	PIPE BEVELING AND CHAMFERING TOOLS CARTRIDGE / KASSETTE FÜR ROHRENDENANFASWERKZEUG		PRICE / PREIS	
		ÖTG-TC..	ÖTG-TC11-4IL ÖTG-TC11-4IR ÖTG-TC16-1AL ÖTG-TC16-1AR ÖTG-TC16-2DL ÖTG-TC16-2DR ÖTG-TC16-3IL ÖTG-TC16-3IR	69,00 € 69,00 € 69,00 € 69,00 € 69,00 € 69,00 € 69,00 € 69,00 €
		TC.T 1102.. TC.T 16T3..		
		EXTERNAL THREADING TOOLHOLDERS / GEWINDE-DREHHALTER FÜR AUSSEN		CUTTING INSERT WENDE PLATTE
		SER / L 0808 E11		36,00 €
		SER / L 1010 E11	11 ER / L	36,00 €
		SER / L 1212 F11		37,00 €
		SER / L 1616 H11		37,00 €
		SER / L 1616 H16C	16 ER / L	41,00 €
	SER / L 2020 K16C	(0.35-3)	43,00 €	
	SER / L 2525 M16C	ISO METRIC	46,00 €	
	SER / L 3232 P16C		54,00 €	
	SER / L 2525 M22C	22 ER / L	51,00 €	
	SER / L 3232 P22C	(3.5-4.5)	59,00 €	
	SER / L 4040 S22C	ISO METRIC	89,00 €	
	SER / L 2525 M16C-T	16 ER / L (1.5-3) TR	46,00 €	
	SER / L 2525 M22C-T	22 ER / L (4-6) TR	51,00 €	
	SER / L 2020 K16C-S	SNDVK 166	55,00 €	
	SER / L 2525 M16C-S	ER / L 16	58,00 €	
SER / L 3232 P16C-S		67,00 €		
EXTERNAL THREADING TOOLHOLDERS FOR SWISS TYPE SLIDING AUTOMATIC LATHES AUSSEN-GEWINDEDREHHALTER FÜR LANGDREHAUTOMATEN		CUTTING INSERT WENDE PLATTE	PRICE / PREIS	
	SER / L 1010 K11-S		41,00 €	
	SER / L 1212 K11-S	11 ER / EL	42,00 €	
	_____			
	_____			
	_____			

INTERNAL THREADING TOOLHOLDERS / GEWINDE-DREHHALTER FÜR INNEN		CUTTING INSERT WENDE PLATTE	PRICE / PREIS
	NEW SIR / L S12X05H 06	06 IR / L	51,00 €
	SIR / L S16X07M 08	08 IR / L	36,00 €
	SIR / L S10H 11		36,00 €
	SIR / L S12K 11	11 IR / L	36,00 €
	SIR / L S16X10M 11	ISO	36,00 €
	SIR / L S16X13M 11		36,00 €
	SIR / L S16M 11		36,00 €
	SIR / L S16x13M 16		36,00 €
	SIR / L S16M 16		36,00 €
	SIR / L S20x16P 16	16 IR / L	38,00 €
	SIR / L S20P 16	(0.35-3)	38,00 €
	SIR / L S25R 16C	ISO METRIC	48,00 €
	SIR / L S32S 16C		63,00 €
	SIR / L S40T 16C		81,00 €
	SIR / L S50U 16C		112,00 €
	SIR / L S20P 22		38,00 €
	SIR / L S25R 22C	22 IR / L	51,00 €
	SIR / L S32S 22C	(3.5-4.5)	68,00 €
	SIR / L S40T 22C	ISO METRIC	81,00 €
	SIR / L S50U 22C		112,00 €
SIR / L S25R 16C-T	16 IR / L (2-3) TR	48,00 €	
SIR / L S32S 16C-T	ISO	63,00 €	
SIR / L S25R 22C-T	22 IR / L (4-6) TR	51,00 €	
SIR / L S32S 22C-T	ISO	68,00 €	



EXTERNAL THREADING TOOLHOLDERS / GEWINDE-DREHHALTER FÜR AUSSEN		CUTTING INSERT WENDE PLATTE	PRICE / PREIS
	TER / L 1616 H16		46,00 €
	TER / L 2020 K16	16 ER / L	48,00 €
	TER / L 2525 M16	ISO	51,00 €
	TER / L 3232 P16		59,00 €
	TER / L 2525 M22	22 ER / L	59,00 €
	TER / L 3232 P22	ISO	67,00 €
	TER / L 4040 S22		97,00 €
	TER / L 2525 M27	27 ER / L	98,00 €
	TER / L 3232 P27	ISO	107,00 €
	TER / L 4040 S27		142,00 €





INTERNAL THREADING TOOLHOLDERS / GEWINDE-DREHHALTER FÜR INNEN		CUTTING INSERT WENDE PLATTE	PRICE / PREIS
	TIR / L S25R 16		53,00 €
	TIR / L S32S 16	16 IR / L	68,00 €
	TIR / L S40T 16	ISO	86,00 €
	TIR / L S50U 16		117,00 €
	TIR / L S25R 22		59,00 €
	TIR / L S32S 22	22 IR / L	77,00 €
	TIR / L S40T 22	ISO	89,00 €
	TIR / L S50U 22		120,00 €
	TIR / L S32S 27	27 IR / L	116,00 €
	TIR / L S40T 27	ISO	129,00 €
	TIR / L S50U 27		151,00 €

EXTERNAL GROOVING TOOLHOLDERS / AUßEN - STECHHALTER		CUTTING INSERT WENDE PLATTE	PRICE / PREIS
 <p>COMPATIBLE WITH KRLY-JD INSERT KOMPATIBEL FÜR WENDESCHNEIDPLATTEN KRLY-JD</p>	ADKT-K-R/L-1212-2-T15	MGM. - 2	70,00 €
	ADKT-K-R/L-1616-2-T15	MGM. - 2	71,00 €
	ADKT-K-R/L-2020-2-T15	MGM. - 2	72,00 €
	ADKT-K-R/L-2525-2-T15	MGM. - 2	73,00 €
	<small>NEW</small> ADKT-K-R/L-3232-2-T15	MGM. - 2	85,00 €
	ADKT-K-R/L-1212-3-T15	MGM. - 3	70,00 €
	ADKT-K-R/L-1616-3-T15	MGM. - 3	71,00 €
	ADKT-K-R/L-2020-3-T20	MGM. - 3	72,00 €
	<small>NEW</small> ADKT-K-R/L-2020-3-R28	MGM. - 3	94,00 €
	ADKT-K-R/L-2525-3-R15	MGM. - 3	73,00 €
	ADKT-K-R/L-2525-3-T22	MGM. - 3	73,00 €
	ADKT-K-R/L-3232-3-T22	MGM. - 3	85,00 €
	ADKT-K-R/L-2020-4-T20	MGM. - 4	72,00 €
	<small>NEW</small> ADKT-K-R/L-2020-4-R25	MGM. - 4	87,00 €
	ADKT-K-R/L-2525-4-T18	MGM. -4	73,00 €
	ADKT-K-R/L-2525-4-T22	MGM. -4	73,00 €
	ADKT-K-R/L-3232-4-T22	MGM. -4	85,00 €
	ADKT-K-R/L-2020-5-T20	MGM. -5	72,00 €
	ADKT-K-R/L-2525-5-T18	MGM. -5	73,00 €
	ADKT-K-R/L-2525-5-T25	MGM. -5	73,00 €
ADKT-K-R/L-3232-5-T25	MGM. -5	85,00 €	
ADKT-K-R/L-2525-6-T25	MGM. -6	73,00 €	
ADKT-K-R/L-3232-6-T25	MGM. -6	85,00 €	
ADKT-K-R/L-3232-8-T32	MGM. -8	112,00 €	
 <p>COMPATIBLE WITH KRLY INSERT KOMPATIBEL FÜR WENDESCHNEIDPLATTEN KRLY</p>	ADKT-KG-R/L-2020-2-T15	KG.. - 2	93,00 €
	ADKT-KG-R/L-2525-2-T15	KG.. - 2	94,00 €
	<small>NEW</small> ADKT-KG-R/L-2525-2-T17	KG.. - 2	94,00 €
	ADKT-KG-R/L-1616-3-T20	KG.. - 3	92,00 €
	ADKT-KG-R/L-2020-3-T20	KG.. - 3	93,00 €
	ADKT-KG-R/L-2525-3-T22	KG.. - 3	94,00 €
	ADKT-KG-R/L-2020-4-T20	KG.. - 4	93,00 €
	ADKT-KG-R/L-2525-4-T22	KG.. - 4	94,00 €
 <p>COMPATIBLE WITH HRN INSERT KOMPATIBEL FÜR WENDESCHNEIDPLATTEN HRN</p>	ADKT-H-R/L-2020-3-T20	S229 - 3	72,00 €
	ADKT-H-R/L-2525-3-T22	S229 - 3	73,00 €
	ADKT-H-R/L-2020-4-T20	S229 - 4	72,00 €
	ADKT-H-R/L-2525-4-T22	S229 - 4	73,00 €
	ADKT-H-R/L-3232-4-T22	S229 - 4	85,00 €
	ADKT-H-R/L-2020-5-T20	S229 - 5	72,00 €
	ADKT-H-R/L-2525-5-T25	S229 - 5	73,00 €
	ADKT-H-R/L-2525-6-T25	S229 - 6	73,00 €
 <p>COMPATIBLE WITH HRN INSERT KOMPATIBEL FÜR WENDESCHNEIDPLATTEN HRN</p>	ADKT-HK-R/L-1616-2-T15	S224 - 2	71,00 €
	ADKT-HK-R/L-2020-2-T15	S224 - 2	72,00 €
	ADKT-HK-R/L-2525-2-T15	S224 - 2	73,00 €
	ADKT-HK-R/L-2020-3-T20	S224 - 3	72,00 €
	ADKT-HK-R/L-2525-3-T22	S224 - 3	73,00 €
	ADKT-HK-R/L-2020-4-T20	S224 - 4	72,00 €
	ADKT-HK-R/L-2525-4-T22	S224 - 4	73,00 €
	ADKT-HS223-R/L-2020-2-T15	S223 - 2	72,00 €

EXTERNAL GROOVING TOOLHOLDERS / AUßEN - STECHHALTER		CUTTING INSERT WENDE PLATTE	PRICE / PREIS
 <p>COMPATIBLE WITH ZCC INSERT KOMPATIBEL FÜR WENDESCHNEIDPLATTEN ZCC</p>	ADKT-ZCC1-R/L-2020-3-T20	ZQMX - 3	72,00 €
	ADKT-ZCC1-R/L-2525-3-T22	ZQMX - 3	73,00 €
	ADKT-ZCC1-R/L-2020-4-T20	ZQMX - 4	72,00 €
	ADKT-ZCC1-R/L-2525-4-T22	ZQMX - 4	73,00 €
	ADKT-ZCC2-R/L-1616-2-T15	Z.BD - 2	71,00 €
	ADKT-ZCC2-R/L-2020-2-T15	Z.BD - 2	72,00 €
	ADKT-ZCC2-R/L-2525-2-T15	Z.BD - 2	73,00 €
	ADKT-ZCC2-R/L-2525-2.5-T15	Z.ED - 2.5	73,00 €
	ADKT-ZCC2-R/L-1616-3-T15	Z.FD - 3	71,00 €
	ADKT-ZCC2-R/L-2020-3-T12	Z.FD - 3	72,00 €
	ADKT-ZCC2-R/L-2020-3-T20	Z.FD - 3	72,00 €
	ADKT-ZCC2-R/L-2525-3-T12	Z.FD - 3	73,00 €
	ADKT-ZCC2-R/L-2525-3-T22	Z.FD - 3	73,00 €
	<small>NEW</small> ADKT-ZCC2-R/L-2525-3-R30	Z.FD - 3	88,00 €
	ADKT-ZCC2-R/L-2020-4-T12	Z.GD - 4	72,00 €
	ADKT-ZCC2-R/L-2020-4-T20	Z.GD - 4	72,00 €
	ADKT-ZCC2-R/L-2525-4-T12	Z.GD - 4	73,00 €
	ADKT-ZCC2-R/L-2525-4-T22	Z.GD - 4	73,00 €
	ADKT-ZCC2-R/L-2020-5-T12	Z.HD - 5	72,00 €
	ADKT-ZCC2-R/L-2020-5-T20	Z.HD - 5	72,00 €
ADKT-ZCC2-R/L-2525-5-T12	Z.HD - 5	73,00 €	
ADKT-ZCC2-R/L-2525-5-T25	Z.HD - 5	73,00 €	
ADKT-ZCC2-R/L-2020-6-T20	Z.KD - 6	72,00 €	
ADKT-ZCC2-R/L-2525-6-T25	Z.KD - 6	73,00 €	
ADKT-ZCC2-R/L-3232-6-T25	Z.KD - 6	85,00 €	
ADKT-ZCC2-R/L-3232-6-T30	Z.KD - 6	123,00 €	
 <p>COMPATIBLE WITH KNMTL INSERT KOMPATIBEL FÜR WENDESCHNEIDPLATTEN KNMTL</p>	ADKT-KM-R/L-2020-2-T15	A4. - 2	72,00 €
	ADKT-KM-R/L-2525-2-T15	A4. - 2	73,00 €
	ADKT-KM-R/L-2020-3-T20	A4. - 3	72,00 €
	ADKT-KM-R/L-2525-3-T22	A4. - 3	73,00 €
	ADKT-KM-R/L-2525-4-T22	A4. - 4	73,00 €
 <p>COMPATIBLE WITH TGTC INSERT KOMPATIBEL FÜR WENDESCHNEIDPLATTEN TGTC</p>	ADKT-TD-R/L-1212-2-T15	TD. - 2	91,00 €
	ADKT-TD-R/L-1616-2-T15	TD. - 2	92,00 €
	ADKT-TD-R/L-2020-2-T15	TD. - 2	93,00 €
	ADKT-TD-R/L-2525-2-T17	TD. - 2	94,00 €
	ADKT-TD-R/L-1212-3-T15	TD. - 3	91,00 €
	ADKT-TD-R/L-1616-3-T15	TD. - 3	92,00 €
	ADKT-TD-R/L-2020-3-T20	TD. - 3	93,00 €
	ADKT-TD-R/L-2525-3-T9	TD. - 3	94,00 €
	ADKT-TD-R/L-2525-3-T22	TD. - 3	94,00 €
	ADKT-TD-R/L-2525-4-T22	TD. - 4	94,00 €
	ADKT-TD-R/L-2525-5-T25	TD. - 5	94,00 €



EXTERNAL GROOVING TOOLHOLDERS / AUßEN - STECHHALTER		CUTTING INSERT WENDE PLATTE	PRICE / PREIS	
	ADKT-123-R/L-1212-1.5-R15	123 - 1.5	70,00 €	
	ADKT-123-R/L-1616-1.5-R15	123 - 1.5	71,00 €	
	ADKT-123-R/L-1616-2-T15	123 - 2	71,00 €	
	<small>NEW</small> ADKT-123-R/L-2020-2-T8	123 - 2	72,00 €	
	ADKT-123-R/L-2020-2-T15	123 - 2	72,00 €	
	ADKT-123-R/L-2525-2-T15	123 - 2	73,00 €	
	ADKT-123-R/L-3232-2-T15	123 - 2	105,00 €	
	ADKT-123-R/L-1616-3-T15	123 - 3	71,00 €	
	ADKT-123-R/L-2020-3-T20	123 - 3	72,00 €	
	ADKT-123-R/L-2525-3-T22	123 - 3	73,00 €	
	ADKT-123-R/L-2020-4-T20	123 - 4	72,00 €	
	ADKT-123-R/L-2525-4-T22	123 - 4	73,00 €	
	ADKT-123-R/L-3232-4-T25	123 - 4	105,00 €	
	ADKT-123-R/L-2020-5-T20	123 - 5	72,00 €	
	ADKT-123-R/L-2525-5-T25	123 - 5	73,00 €	
<small>NEW</small> ADKT-123-R/L-3232-6-T15	123 - 6	146,00 €		
COMPATIBLE WITH SNDVK INSERT KOMPATIBEL FÜR WENDESCHNEIDPLATTEN SNDVK				
	ADKT-151.22-R/L-1616-2-T15	151.2 - 2	71,00 €	
	ADKT-151.22-R/L-2020-2-T15	151.2 - 2	72,00 €	
	ADKT-151.22-R/L-2525-2-T15	151.2 - 2	73,00 €	
	ADKT-151.22-R/L-1616-3-T15	151.2 - 3	71,00 €	
	ADKT-151.22-R/L-2020-3-T20	151.2 - 3	72,00 €	
	ADKT-151.22-R/L-2525-3-T22	151.2 - 3	73,00 €	
	ADKT-151.22-R/L-1616-4-T15	151.2 - 4	71,00 €	
	ADKT-151.22-R/L-2020-4-T20	151.2 - 4	72,00 €	
	ADKT-151.22-R/L-2525-4-T22	151.2 - 4	73,00 €	
	ADKT-151.22-R/L-2020-5-T20	151.2 - 5	72,00 €	
	ADKT-151.22-R/L-2525-5-T25	151.2 - 5	73,00 €	
COMPATIBLE WITH SNDVK INSERT KOMPATIBEL FÜR WENDESCHNEIDPLATTEN SNDVK				
	ADKT-151.23-R/L-1616-2-T15	151.2 - 2	71,00 €	
	ADKT-151.23-R/L-2020-2-T15	151.2 - 2	72,00 €	
	ADKT-151.23-R/L-2525-2-T15	151.2 - 2	73,00 €	
	<small>NEW</small> ADKT-151.23-R/L-1616-2.5-T15	151.2 - 2.5	71,00 €	
	ADKT-151.23-R/L-2020-2.5-T15	151.2 - 2.5	72,00 €	
	ADKT-151.23-R/L-2525-2.5-T15	151.2 - 2.5	73,00 €	
	ADKT-151.23-R/L-1212-3-T15	151.2 - 3	70,00 €	
	ADKT-151.23-R/L-1616-3-T15	151.2 - 3	71,00 €	
	ADKT-151.23-R/L-2020-3-T20	151.2 - 3	72,00 €	
	ADKT-151.23-R/L-2525-3-T20	151.2 - 3	73,00 €	
	ADKT-151.23-R/L-2525-3-T22	151.2 - 3	73,00 €	
	ADKT-151.23-R/L-1616-4-T15	151.2 - 4	71,00 €	
	ADKT-151.23-R/L-2020-4-T20	151.2 - 4	72,00 €	
	ADKT-151.23-R/L-2525-4-T22	151.2 - 4	73,00 €	
	ADKT-151.23-R/L-2020-5-T20	151.2 - 5	72,00 €	
	ADKT-151.23-R/L-2525-5-T25	151.2 - 5	73,00 €	
	COMPATIBLE WITH SNDVK INSERT KOMPATIBEL FÜR WENDESCHNEIDPLATTEN SNDVK			

EXTERNAL GROOVING TOOLHOLDERS / AUßEN - STECHHALTER		CUTTING INSERT WENDE PLATTE	PRICE / PREIS
 <p>COMPATIBLE WITH SNDVK INSERT KOMPATIBEL FÜR WENDESCHNEIDPLATTEN SNDVK</p>	ADKT-154-91-R/L-2020-3-T4	154.91 - 3	72,00 €
	ADKT-154-91-R/L 2525-3-T4	154.91 - 3	73,00 €
	ADKT-154-91-R/L 2020-5-T5	154.91 - 5	72,00 €
	ADKT-154-91-R/L 2525-5-T5	154.91 - 5	73,00 €
 <p>COMPATIBLE WITH ARN INSERT KOMPATIBEL FÜR WENDESCHNEIDPLATTEN ARN</p>	ADKT-ARN-R/L-2020-2-T15	LOMR. - 2	72,00 €
	ADKT-ARN-R/L-2525-2-T15	LOMR. - 2	73,00 €
	ADKT-ARN-R/L-2020-3-T20	LOMR. - 3	72,00 €
	ADKT-ARN-R/L-2525-3-T22	LOMR. - 3	73,00 €
 <p>COMPATIBLE WITH SMTM INSERT KOMPATIBEL FÜR WENDESCHNEIDPLATTEN SMTM</p>	ADKT-SWC-R/L-2020-2-T25	WCF. - 2	102,00 €
	ADKT-SWC-R/L-2020-3-T25	WCF. - 3	102,00 €
 <p>COMPATIBLE WITH SMTM INSERT KOMPATIBEL FÜR WENDESCHNEIDPLATTEN SMTM</p>	ADKT-SGC-R/L-1212-2-R15	GCM N20	91,00 €
	ADKT-SGC-R/L-1616-2-R15	GCM N20	92,00 €
	ADKT-SGC-R/L-2020-2-R20	GCM N20	93,00 €
	ADKT-SGC-R/L-2525-2-R20	GCM N20	94,00 €
	ADKT-SGC-R/L-1212-3-R15	GCM N30	91,00 €
	ADKT-SGC-R/L-1616-3-R15	GCM N30	92,00 €
	ADKT-SGC-R/L-2020-3-R22	GCM N30	93,00 €
	ADKT-SGC-R/L-2525-3-R15	GCM N30	94,00 €
	ADKT-SGC-R/L-2525-3-R22	GCM N30	94,00 €
	ADKT-SGC-R/L-2525-4-R25	GCM N40	94,00 €
 <p>COMPATIBLE WITH HRN INSERT KOMPATIBEL FÜR WENDESCHNEIDPLATTEN HRN</p>	ADKT-H22-R/L-1616-(0.5-2)-T6	S312 - (0.5-2)	71,00 €
	ADKT-H22-R/L-2020-(0.5-2)-T6	S312 - (0.5-2)	72,00 €
	ADKT-H22-R/L-2525-(0.5-2)-T6	S312 - (0.5-2)	73,00 €

EXTERNAL GROOVING TOOLHOLDERS / AUßEN - STECHHALTER		CUTTING INSERT WENDE PLATTE	PRICE / PREIS
 <p>COMPATIBLE WITH LMNA INSERT KOMPATIBEL FÜR WENDESCHNEIDPLATTEN LMNA</p>	ADKT-LGC-R/L-1616-2-D40	GCTX - 2	92,00 €
	ADKT-LGC-R/L-2020-2-D40	GCTX - 2	93,00 €
	ADKT-LGC-R/L-2525-2-D40	GCTX - 2	94,00 €
	ADKT-LGC-R/L-1616-3-T20	GCTX - 3	92,00 €
	ADKT-LGC-R/L-2020-3-T20	GCTX - 3	93,00 €
	ADKT-LGC-R/L-2525-3-T20	GCTX - 3	94,00 €
 <p>COMPATIBLE WITH WLTR INSERT KOMPATIBEL FÜR WENDESCHNEIDPLATTEN WLTR</p>	ADKT-WGX16-R/L-2020-2-R16	GX16. - 2	93,00 €
	ADKT-WGX24-R/L-2525-3-T22	GX24. - 3	94,00 €
	ADKT-WGX24-R/L-2525-4-T22	GX24. - 4	94,00 €
	ADKT-WGX24-R/L-2525-5-T25	GX24. - 5	94,00 €
	ADKT-WGX24-R/L-3232-5-T25	GX24. - 5	108,00 €
 <p><b>NEW</b> COMPATIBLE WITH PLBT INSERT KOMPATIBEL FÜR WENDESCHNEIDPLATTEN PLBT</p>	ADKT-GP-R/L-2020-2-T15	GP - 2	93,00 €
	ADKT-GP-R/L-2525-2-T15	GP - 2	94,00 €
	ADKT-GP-R/L-2020-3-T20	GP - 3	93,00 €
	ADKT-GP-R/L-2525-3-T22	GP - 3	94,00 €
	ADKT-GP-R/L-2525-4-T22	GP - 4	94,00 €
	ADKT-GP-R/L-2525-5-T25	GP - 5	94,00 €
 <p><b>NEW</b> COMPATIBLE WITH CRTZT INSERT KOMPATIBEL FÜR WENDESCHNEIDPLATTEN CRTZT</p>	ADKT-CD-R/L-2020-3-R20	GX24 0300	72,00 €
	ADKT-CD-R/L-2525-3-R23	GX24 0300	73,00 €
<b>L TYPE FACE GROOVING TOOLHOLDERS / AXIAL- STECHHALTER L TYPE</b>		<b>CUTTING INSERT WENDE PLATTE</b>	<b>PRICE / PREIS</b>
 <p>COMPATIBLE WITH ZCC INSERT KOMPATIBEL FÜR WENDESCHNEIDPLATTEN ZCC</p>	ALKT-ZCC2-R/L-2525-35-45-3-T10	Z.FD - 3	117,00 €
	ALKT-ZCC2-R/L-2525-39-55-3-T10	Z.FD - 3	117,00 €
	ALKT-ZCC2-R/L-2525-35-∅-3-T4	Z.FD - 3	117,00 €
	ALKT-ZCC2-R/L-2525-40-60-4-T14	Z.GD - 4	117,00 €
	ALKT-ZCC2-R/L-2525-52-80-4-T14	Z.GD - 4	117,00 €
	ALKT-ZCC2-R/L-2525-72-110-4-T14	Z.GD - 4	117,00 €
	ALKT-ZCC2-R/L-2525-100-230-4-T14	Z.GD - 4	117,00 €
	ALKT-ZCC2-R/L-2525-40-∅-4-T4	Z.GD - 4	117,00 €







EXTERNAL GROOVING TOOLHOLDERS FOR SWISS TYPE SLIDING AUTOMATIC LATHES <i>Werkzeuge zur Stechbearbeitung auf Langdrehautomaten</i>		CUTTING INSERT <i>WENDE PLATTE</i>	PRICE / PREIS
 <p>COMPATIBLE WITH TGTC INSERT KOMPATIBEL FÜR WENDESCHNEIDPLATTEN TGTC</p>	ADKT-TD-R/L-1212-2-T12-K-S	TD. - 2	91,00 €
	ADKT-TD-R/L-1616-2-T16-K-S	TD. - 2	92,00 €
	ADKT-TD-R/L-1212-3-T12-K-S	TD. - 3	91,00 €
	ADKT-TD-R/L-1616-3-T16-K-S	TD. - 3	92,00 €
 <p>COMPATIBLE WITH ZCC INSERT KOMPATIBEL FÜR WENDESCHNEIDPLATTEN ZCC</p>	ADKT-ZCC2-R/L-1010-2-T12-K-S	Z.BD - 2	91,00 €
	ADKT-ZCC2-R/L-1212-2-T12-K-S	Z.BD - 2	91,00 €
	ADKT-ZCC2-R/L-1616-2-R16-K-S	Z.BD - 2	92,00 €
	ADKT-ZCC2-R/L-1212-3-T12-K-S	Z.FD - 2	91,00 €
 <p><b>NEW</b> COMPATIBLE WITH KRLY INSERT KOMPATIBEL FÜR WENDESCHNEIDPLATTEN KRLY</p>	ADKT-KG-R/L-1212-2-R12-K-S	KG. - 2	100,00 €
	ADKT-KG-R/L-1212-3-R12-K-S	KG. - 3	100,00 €
 <p><b>NEW</b> COMPATIBLE WITH ISCR INSERT KOMPATIBEL FÜR WENDESCHNEIDPLATTEN ISCR</p>	ADKT-I-R/L-0808-2-R10-S	DGN - 2	89,00 €
	ADKT-I-R/L-1010-2-R10-K-S	DGN - 2	91,00 €
	ADKT-I-R/L-1212-2-R12-K-S	DGN - 2	91,00 €
	ADKT-I-R/L-1616-3-R16-S	DGN - 3	91,00 €
 <p><b>NEW</b> COMPATIBLE WITH WLTR INSERT KOMPATIBEL FÜR WENDESCHNEIDPLATTEN WLTR</p>	ADKT-WGX16-R/L-1616-2-R16-K-S	GX16. - 2	92,00 €
	ADKT-WGX24-R/L-1616-3-R16-K-S	GX24. - 3	105,00 €

Ordering Example/Beispiel Bestellformular: 1pcs. ADKT-TD-R-1212-2-T12-K-S

FACE GROOVING TOOLHOLDERS / AXIAL- STECHHALTER		CUTTING INSERT WENDE PLATTE	PRICE / PREIS
 <p>COMPATIBLE WITH KRLY INSERT KOMPATIBEL FÜR WENDESCHNEIDPLATTEN KRLY</p>	AAKT-K-R/L-2525-34-45-3-T17	MGM. - 3	112,00 €
	AAKT-K-R/L-2525-39-55-3-T17	MGM. - 3	112,00 €
	AAKT-K-R/L-2525-49-80-3-T17	MGM. - 3	112,00 €
	AAKT-K-R/L-2525-70-110-3-T17	MGM. - 3	112,00 €
	AAKT-K-R/L-2525-100-150-3-T17	MGM. - 3	112,00 €
	AAKT-K-R/L-2525-80-180-3-T32	MGM. - 3	117,00 €
	NEW AAKT-K-R/L-2525-175-215-3-T22	MGM. - 3	112,00 €
	AAKT-K-R/L-2525-50-85-4-T22	MGM. - 4	112,00 €
	AAKT-K-R/L-2525-70-110-4-T22	MGM. - 4	112,00 €
	AAKT-K-R/L-2525-100-150-4-T22	MGM. - 4	112,00 €
	AAKT-K-R/L-2525-80-180-4-T32	MGM. - 4	117,00 €
	AAKT-K-R/L-2525-180-800-4-T32	MGM. - 4	117,00 €
	AAKT-K-R/L-2525-70-110-5-T25	MGM. - 5	112,00 €
	AAKT-K-R/L-2525-100-150-5-T25	MGM. - 5	112,00 €
	AAKT-K-R/L-2525-140-200-5-T25	MGM. - 5	112,00 €
	AAKT-K-R/L-2525-80-180-5-T32	MGM. - 5	117,00 €
	AAKT-K-R/L-2525-180-800-5-T32	MGM. - 5	117,00 €
	NEW AAKT-K-R/L-2525-60-100-6-T25	MGM. - 6	112,00 €
	NEW AAKT-K-R/L-2525-60-100-6-T35	MGM. - 6	122,00 €
	NEW AAKT-K-R/L-2525-100-200-6-T25	MGM. - 6	112,00 €
	NEW AAKT-K-R/L-2525-100-200-6-T35	MGM. - 6	122,00 €
	AAKT-K-R/L-2525-140-300-6-T35	MGM. - 6	122,00 €
AAKT-K-R/L-2525-140-300-8-T35	MGM. - 8	128,00 €	
AAKT-K-R/L-3232-140-350-8-T35	MGM. - 8	138,00 €	

FACE GROOVING TOOLHOLDERS / AXIAL- STECHHALTER		CUTTING INSERT WENDE PLATTE	PRICE / PREIS
 <p>COMPATIBLE WITH ZCC INSERT KOMPATIBEL FÜR WENDESCHNEIDPLATTEN ZCC</p>	NEW AAKT-ZCC2-R/L-2525-140-180-2-T4	Z.BD - 2	112,00 €
	AAKT-ZCC2-R/L-2525-35-45-3-T17	Z.FD - 3	112,00 €
	AAKT-ZCC2-R/L-2525-39-55-3-T17	Z.FD - 3	112,00 €
	AAKT-ZCC2-R/L-2525-49-80-3-T17	Z.FD - 3	112,00 €
	AAKT-ZCC2-R/L-2525-70-110-3-T17	Z.FD - 3	112,00 €
	AAKT-ZCC2-R/L-2525-100-150-3-T17	Z.FD - 3	112,00 €
	AAKT-ZCC2-R/L-2525-40-60-4-T22	Z.GD - 4	112,00 €
	AAKT-ZCC2-R/L-2525-52-80-4-T22	Z.GD - 4	112,00 €
	AAKT-ZCC2-R/L-2525-72-110-4-T22	Z.GD - 4	112,00 €
	AAKT-ZCC2-R/L-2525-100-150-4-T22	Z.GD - 4	112,00 €
	AAKT-ZCC2-R/L-2525-140-200-4-T22	Z.GD - 4	112,00 €
	AAKT-ZCC2-R/L-2525-55-95-5-T25	Z.HD - 5	112,00 €
	AAKT-ZCC2-R/L-2525-85-140-5-T25	Z.HD - 5	112,00 €
	AAKT-ZCC2-R/L-2525-130-200-5-T25	Z.HD - 5	112,00 €
	AAKT-ZCC2-R/L-2525-190-400-5-T25	Z.HD - 5	112,00 €
	AAKT-ZCC2-R/L-2525-190-400-5-T35	Z.HD - 5	133,00 €
	AAKT-ZCC2-R/L-2525-200-500-5-T17	Z.HD - 5	112,00 €
	NEW AAKT-ZCC2-R/L-2525-60-110-6-T15	Z.KD - 6	112,00 €

FACE GROOVING TOOLHOLDERS / AXIAL- STECHHALTER		CUTTING INSERT WENDE PLATTE	PRICE / PREIS
 <p>COMPATIBLE WITH ISCR INSERT KOMPATIBEL FÜR WENDESCHNEIDPLATTEN ISCR</p>	NEW AAKT-IG-R/L-2525-40-60-4-T25	DGN / GRP - 4	129,00 €
	NEW AAKT-IG-R/L-2525-52-80-4-T25	DGN / GRP - 4	129,00 €
	AAKT-IG-R/L-2525-70-110-4-T28	DGN / GRP - 4	129,00 €
	AAKT-IG-R/L-2525-110-200-4-T28	DGN / GRP - 4	129,00 €
	AAKT-IG-R/L-2525-110-200-4-T32	DGN / GRP - 4	129,00 €
	AAKT-IG-R/L-2525-180-800-4-T28	DGN / GRP - 4	129,00 €
	AAKT-IG-R/L-2525-70-110-5-T32	DGN / GRP - 5	129,00 €
	AAKT-IG-R/L-2525-110-200-5-T32	DGN / GRP - 5	129,00 €
	AAKT-IG-R/L-2525-180-800-5-T32	DGN / GRP - 5	129,00 €
	AAKT-IG-R/L-2525-58-100-6-T32	DGN / GRP - 6	129,00 €
AAKT-IG-R/L-2525-88-180-6-T32	DGN / GRP - 6	129,00 €	



BLADES FOR PARTING AND DEEP GROOVING / Stechschwert zur Außenbearbeitung		CUTTING INSERT WENDE PLATTE	PRICE / PREIS
 <p>COMPATIBLE WITH ISCR INSERT KOMPATIBEL FÜR WENDESCHNEIDPLATTEN ISCR</p>	AKL-I-26-2	DGN - 2	100,00 €
	AKL-I-32-2	DGN - 2	106,00 €
	AKL-I-26-3	DGN - 3	100,00 €
	AKL-I-32-3	DGN - 3	106,00 €
	AKL-I-26-4	DGN / GRP - 4	100,00 €
	AKL-I-32-4	DGN / GRP - 4	106,00 €
 <p>NEW COMPATIBLE WITH SNDVK INSERT KOMPATIBEL FÜR WENDESCHNEIDPLATTEN SNDVK</p>	AKL-123-32-3	123 - 3	106,00 €
	AKL-123-32-4	123 - 4	106,00 €
 <p>NEW COMPATIBLE WITH TGTC INSERT KOMPATIBEL FÜR WENDESCHNEIDPLATTEN TGTC</p>	AKL-TD-32-2	TD. - 2	106,00 €
	AKL-TD-32-3	TD. - 3	106,00 €

BLOCKS FOR PARTING AND DEEP GROOVING BLADES / Spannblock für Stechschwert		PRICE / PREIS
	ALBU-20-26	92,00 €
	ALBU-20-32	92,00 €
	ALBU-25-26	102,00 €
	ALBU-25-32	102,00 €
	ALBU-32-32	112,00 €

INTERNAL GROOVING TOOLHOLDERS / INNEN- STECHHALTER		CUTTING INSERT WENDE PLATTE	PRICE / PREIS
	AIKT-K-R/L-16-2-T4	MGM. - 2	62,00 €
	AIKT-K-R/L-20-2-T4	MGM. - 2	67,00 €
	AIKT-K-R/L-25-2-T6	MGM. - 2	72,00 €
	AIKT-K-R/L-20-3-T6	MGM. - 3	67,00 €
	AIKT-K-R/L-20-3-T7	MGM. - 3	71,00 €
	AIKT-K-R/L-25-3-T6	MGM. - 3	72,00 €
	AIKT-K-R/L-25-3-T10	MGM. - 3	80,00 €
	AIKT-K-R/L-32-3-T6	MGM. - 3	85,00 €
	AIKT-K-R/L-32-3-T12	MGM. - 3	92,00 €
	AIKT-K-R/L-40-3-T6	MGM. - 3	102,00 €
	AIKT-K-R/L-40-3-T12	MGM. - 3	112,00 €
	AIKT-K-R/L-20-4-T6	MGM. - 4	67,00 €
	AIKT-K-R/L-20-4-T7	MGM. - 4	71,00 €
	AIKT-K-R/L-25-4-T6	MGM. - 4	72,00 €
	AIKT-K-R/L-25-4-T10	MGM. - 4	80,00 €
	AIKT-K-R/L-32-4-T6	MGM. - 4	85,00 €
	AIKT-K-R/L-32-4-T12	MGM. - 4	92,00 €
	AIKT-K-R/L-40-4-T6	MGM. - 4	102,00 €
	AIKT-K-R/L-40-4-T12	MGM. - 4	112,00 €
	AIKT-K-R/L-25-5-T7	MGM. - 5	72,00 €
AIKT-K-R/L-32-5-T7	MGM. - 5	85,00 €	
AIKT-K-R/L-40-5-T7	MGM. - 5	102,00 €	
COMPATIBLE WITH KRLY-JD INSERT KOMPATIBEL FÜR WENDESCHNEIDPLATTEN KRLY-JD			
	AIKT-KG-R/L-25-2-T7	KG.. - 2	80,00 €
	AIKT-KG-R/L-25-3-T7	KG.. - 3	80,00 €
	AIKT-KG-R/L-40-3-T8	KG.. - 3	112,00 €
	AIKT-KG-R/L-25-4-T8	KG.. - 4	80,00 €
COMPATIBLE WITH KRLY INSERT KOMPATIBEL FÜR WENDESCHNEIDPLATTEN KRLY			
	AIKT-H-R/L-25-3-T7	S229 - 3	72,00 €
	AIKT-H-R/L-32-3-T7	S229 - 3	85,00 €
	AIKT-H-R/L-40-3-T7	S229 - 3	102,00 €
	AIKT-H-R/L-25-4-T7	S229 - 4	72,00 €
	AIKT-H-R/L-32-4-T7	S229 - 4	85,00 €
	AIKT-H-R/L-40-4-T7	S229 - 4	102,00 €
	AIKT-H-R/L-25-5-T7	S229 - 5	72,00 €
	AIKT-H-R/L-32-5-T7	S229 - 5	85,00 €
	AIKT-H-R/L-40-5-T7	S229 - 5	102,00 €
COMPATIBLE WITH HRN INSERT KOMPATIBEL FÜR WENDESCHNEIDPLATTEN HRN			

INTERNAL GROOVING TOOLHOLDERS / INNEN- STECHHALTER		CUTTING INSERT WENDE PLATTE	PRICE / PREIS
 <p>COMPATIBLE WITH HRN INSERT KOMPATIBEL FÜR WENDESCHNEIDPLATTEN HRN</p>	AIKT-HK-R/L-20-2-T6	S224 - 2	67,00 €
	AIKT-HK-R/L-25-2-T6	S224 - 2	72,00 €
	AIKT-HK-R/L-20-3-T6	S224 - 3	67,00 €
	AIKT-HK-R/L-25-3-T6	S224 - 3	72,00 €
	AIKT-HK-R/L-32-3-T6	S224 - 3	85,00 €
	AIKT-HK-R/L-20-4-T6	S224 - 4	67,00 €
	AIKT-HK-R/L-25-4-T6	S224 - 4	72,00 €
	AIKT-HK-R/L-32-4-T6	S224 - 4	85,00 €
	AIKT-HS223-R/L-20-2-T5	S223 - 2	67,00 €
	AIKT-HS223-R/L-25-2-T5	S223 - 2	72,00 €
AIKT-HS223-R/L-20-3-T6	S223 - 3	67,00 €	
AIKT-HS223-R/L-25-3-T6	S223 - 3	72,00 €	
 <p>COMPATIBLE WITH SNDVK INSERT KOMPATIBEL FÜR WENDESCHNEIDPLATTEN SNDVK</p>	AIKT-154.91-R/L-16-3-T3	154.91 - 3	62,00 €
	AIKT-154.91-R/L-20-3-T4	154.91 - 3	67,00 €
	AIKT-154.91-R/L-25-3-T4	154.91 - 3	72,00 €
	AIKT-154.91-R/L-25-5-T5	154.91 - 5	72,00 €
	AIKT-154.91-R/L-32-5-T5	154.91 - 5	85,00 €
 <p>COMPATIBLE WITH ZCC INSERT KOMPATIBEL FÜR WENDESCHNEIDPLATTEN ZCC</p>	NEW AIKT-ZCC2-R/L-16-2-T4	Z.BD - 2	62,00 €
	AIKT-ZCC2-R/L-20-3-T5	Z.FD - 3	67,00 €
	AIKT-ZCC2-R/L-25-3-T5	Z.FD - 3	72,00 €
	AIKT-ZCC2-R/L-32-3-T6	Z.FD - 3	85,00 €
	AIKT-ZCC2-R/L-32-3-T8	Z.FD - 3	96,00 €
	AIKT-ZCC2-R/L-25-4-T6	Z.GD - 4	72,00 €
	AIKT-ZCC2-R/L-32-4-T7	Z.GD - 4	85,00 €
	AIKT-ZCC2-R/L-32-4-T8	Z.GD - 4	96,00 €
	AIKT-ZCC2-R/L-32-4-T10	Z.GD - 4	96,00 €
	AIKT-ZCC2-R/L-32-5-T7	Z.HD - 5	85,00 €
	AIKT-ZCC2-R/L-32-5-T8	Z.HD - 5	96,00 €
	AIKT-ZCC2-R/L-40-5-T8	Z.HD - 5	102,00 €
AIKT-ZCC2-R/L-40-5-T10	Z.HD - 5	112,00 €	
 <p>NEW COMPATIBLE WITH ISCR INSERT KOMPATIBEL FÜR WENDESCHNEIDPLATTEN ISCR</p>	AIKT-IGE-R/L-16-2-T2.5-H	GEPI - 2	81,00 €
	AIKT-IGE-R/L-16-3-T2.5-H	GEPI - 3	81,00 €
 <p>COMPATIBLE WITH KNMTL INSERT KOMPATIBEL FÜR WENDESCHNEIDPLATTEN KNMTL</p>	AIKT-KM-R/L-20-2-T7	A4. - 2	67,00 €
	AIKT-KM-R/L-20-3-T7	A4. - 3	67,00 €
	AIKT-KM-R/L-25-3-T10	A4. - 3	72,00 €
	AIKT-KM-R/L-32-3-T12	A4. - 3	85,00 €
	AIKT-KM-R/L-40-3-T12	A4. - 3	102,00 €
	AIKT-KM-R/L-20-4-T7	A4. - 4	67,00 €

INTERNAL GROOVING TOOLHOLDERS / INNEN- STECHHALTER		CUTTING INSERT WENDE PLATTE	PRICE / PREIS
 <p>COMPATIBLE WITH ISCR INSERT KOMPATIBEL FÜR WENDESCHNEIDPLATTEN ISCR</p>	AIKT-ITG-R/L-16-3-T6-H	TGM. - 3	81,00 €
	AIKT-ITG-R/L-20-3-T6-H	TGM. - 3	89,00 €
	AIKT-ITG-R/L-25-3-T8-H	TGM. - 3	98,00 €
	AIKT-ITG-R/L-32-3-T8-H	TGM. - 3	118,00 €
	AIKT-ITG-R/L-20-4-T6-H	TGM. - 4	89,00 €
	AIKT-ITG-R/L-25-4-T7-H	TGM. - 4	98,00 €
	AIKT-ITG-R/L-25-4-T9-H	TGM. - 4	102,00 €
	AIKT-ITG-R/L-32-4-T11-H	TGM. - 4	118,00 €
AIKT-ITG-R/L-40-4-T11-H	TGM. - 4	204,00 €	
 <p>COMPATIBLE WITH ISCR INSERT KOMPATIBEL FÜR WENDESCHNEIDPLATTEN ISCR</p>	AIKT-IG-R/L-25-4-T10-H	DGN / GRP - 4	102,00 €
	AIKT-IG-R/L-32-4-T10-H	DGN / GRP - 4	123,00 €
	AIKT-IG-R/L-40-4-T12-H	DGN / GRP - 4	204,00 €
	AIKT-IG-R/L-25-5-T10-H	DGN / GRP - 5	102,00 €
	AIKT-IG-R/L-32-5-T10-H	DGN / GRP - 5	123,00 €
	AIKT-IG-R/L-40-5-T12-H	DGN / GRP - 5	204,00 €
	AIKT-IG-R/L-50-5-T12-H	DGN / GRP - 5	255,00 €
 <p>COMPATIBLE WITH ISCR INSERT KOMPATIBEL FÜR WENDESCHNEIDPLATTEN ISCR</p>	AIKT-IGI-R/L-20-3-T4	GIMIY / GIPI - 3	89,00 €
	AIKT-IGI-R/L-25-3-T5	GIMIY / GIPI - 3	98,00 €
	AIKT-IGI-R/L-32-3-T5	GIMIY / GIPI - 3	118,00 €
	<b>NEW</b> AIKT-IGI-R/L-20-4-T4	GIMIY / GIPI - 4	89,00 €
 <p>COMPATIBLE WITH ISCR INSERT KOMPATIBEL FÜR WENDESCHNEIDPLATTEN ISCR</p>	AIKT-I-R/L-20-3-T5	DGN - 3	67,00 €
	AIKT-I-R/L-25-3-T6	DGN - 3	72,00 €
 <p><b>NEW</b></p> <p>COMPATIBLE WITH PLBT INSERT KOMPATIBEL FÜR WENDESCHNEIDPLATTEN PLBT</p>	AIKT-GP-R/L-20-2-T4	GP - 2	71,00 €
	AIKT-GP-R/L-20-3-T6	GP - 3	71,00 €
	AIKT-GP-R/L-25-3-T6	GP - 3	80,00 €
	AIKT-GP-R/L-32-3-T6	GP - 3	92,00 €
	AIKT-GP-R/L-20-4-T6	GP - 4	71,00 €
	AIKT-GP-R/L-25-4-T6	GP - 4	80,00 €
	AIKT-GP-R/L-32-4-T6	GP - 4	92,00 €

INTERNAL GROOVING TOOLHOLDERS / INNEN- STECHHALTER		CUTTING INSERT WENDE PLATTE	PRICE / PREIS
 <p><b>NEW</b></p> <p>COMPATIBLE WITH SMTM INSERT KOMPATIBEL FÜR WENDESCHNEIDPLATTEN SMTM</p>	AIKT-SGC-R/L-25-3-T6	GCM N30	80,00 €
	AIKT-SGC-R/L-32-3-T6	GCM N30	131,00 €
	AIKT-SGC-R/L-40-3-T6	GCM N30	152,00 €
 <p><b>NEW</b></p> <p>COMPATIBLE WITH SNDVK INSERT KOMPATIBEL FÜR WENDESCHNEIDPLATTEN SNDVK</p>	AIKT-123-R/L-32-2-T7	123 - 2	85,00 €
	AIKT-123-R/L-20-3-T6	123 - 3	67,00 €
	AIKT-123-R/L-25-3-T7	123 - 3	72,00 €
	AIKT-123-R/L-32-3-T9	123 - 3	92,00 €
	AIKT-123-R/L-20-4-T8	123 - 4	71,00 €
	AIKT-123-R/L-25-4-T7	123 - 4	72,00 €
	AIKT-123-R/L-32-4-T7	123 - 4	85,00 €
	AIKT-123-R/L-32-4-T10	123 - 4	92,00 €
	AIKT-123-R/L-25-5-T8	123 - 5	72,00 €
	AIKT-123-R/L-32-5-T11	123 - 5	92,00 €
MINI GROOVING TOOL / MINI - STECHWERKZEUGE		CUTTING INSERT WENDE PLATTE	PRICE / PREIS
 <p>COMPATIBLE WITH SNDVK INSERT KOMPATIBEL FÜR WENDESCHNEIDPLATTEN SNDVK</p>	AIKT-MB07-A16-090-15	MB - 07	92,00 €
	AIKT-MB07-A16-090-22	MB - 07	92,00 €
	AIKT-MB09-A16-090-19	MB - 09	92,00 €
	AIKT-MB09-A16-110-40	MB - 09	92,00 €
	AIKT-MB09-A16-095-28	MB - 09	92,00 €

Ordering Example/Beispiel Bestellformular: 1pcs. AIKT-SGC-R-25-3-T6



## U-DRILL SYSTEM / VOLLBOHRER (WCM.)

D2	CODE / TYP	TOOL DIMENSIONS (mm) <i>MAß</i>						CUTTING INSERT WENDE PLATTE	PRICE / PREIS
		d	d <sub>1</sub>	d <sub>2</sub>	l <sub>1</sub>	l <sub>2</sub>	l <sub>3</sub>		
	ATUM 16XD2 WCM. 030208	16	25	34	32	54	56	WCM. 030208	147,00 €
	ATUM 16.5XD2 WCM. 030208	16,5	25	34	32	54	56	WCM. 030208	147,00 €
	ATUM 17XD2 WCM. 030208	17	25	34	34	56	56	WCM. 030208	147,00 €
	ATUM 17.5XD2 WCM. 030208	17,5	25	34	34	56	56	WCM. 030208	147,00 €
	ATUM 18XD2 WCM. 030208	18	25	34	36	58	56	WCM. 030208	147,00 €
	ATUM 18.5XD2 WCM. 030208	18,5	25	34	36	58	56	WCM. 030208	147,00 €
	ATUM 19XD2 WCM. 030208	19	25	34	38	60	56	WCM. 030208	147,00 €
	ATUM 19.5XD2 WCM. 030208	19,5	25	34	38	60	56	WCM. 030208	147,00 €
	ATUM 20XD2 WCM. 040208	20	25	34	40	62	56	WCM. 040208	157,00 €
	ATUM 20.5XD2 WCM. 040208	20,5	25	34	40	62	56	WCM. 040208	157,00 €
	ATUM 21XD2 WCM. 040208	21	25	34	42	64	56	WCM. 040208	157,00 €
	ATUM 21.5XD2 WCM. 040208	21,5	25	34	42	64	56	WCM. 040208	157,00 €
	ATUM 22XD2 WCM. 040208	22	25	34	44	66	56	WCM. 040208	157,00 €
	ATUM 22.5XD2 WCM. 040208	22,5	25	34	44	66	56	WCM. 040208	157,00 €
	ATUM 23XD2 WCM. 040208	23	25	34	46	68	56	WCM. 040208	157,00 €
	ATUM 23.5XD2 WCM. 040208	23,5	25	34	46	68	56	WCM. 040208	157,00 €
	ATUM 24XD2 WCM. 050308	24	25	34	48	70	56	WCM. 050308	163,00 €
	ATUM 24.5XD2 WCM. 050308	24,5	25	34	48	70	56	WCM. 050308	163,00 €
	ATUM 25XD2 WCM. 050308	25	25	34	50	72	56	WCM. 050308	163,00 €
	ATUM 25.5XD2 WCM. 050308	25,5	25	34	50	72	56	WCM. 050308	163,00 €
	ATUM 26XD2 WCM. 050308	26	25	34	52	74	56	WCM. 050308	163,00 €
	ATUM 26.5XD2 WCM. 050308	26,5	25	34	52	74	56	WCM. 050308	163,00 €
	ATUM 27XD2 WCM. 050308	27	25	34	54	76	56	WCM. 050308	163,00 €
	ATUM 27.5XD2 WCM. 050308	27,5	25	34	54	76	56	WCM. 050308	163,00 €
	ATUM 28XD2 WCM. 050308	28	25	34	56	78	56	WCM. 050308	163,00 €
	ATUM 28.5XD2 WCM. 050308	28,5	25	34	56	78	56	WCM. 050308	163,00 €
	ATUM 29XD2 WCM. 050308	29	25	34	58	80	56	WCM. 050308	163,00 €
	ATUM 29.5XD2 WCM. 050308	29,5	25	34	58	80	56	WCM. 050308	163,00 €
	ATUM 30XD2 WCM. 06T308	30	32	44	60	87	60	WCM. 06T308	174,00 €
	ATUM 31XD2 WCM. 06T308	31	32	44	62	89	60	WCM. 06T308	174,00 €
	ATUM 32XD2 WCM. 06T308	32	32	44	64	91	60	WCM. 06T308	174,00 €
	ATUM 33XD2 WCM. 06T308	33	32	44	66	93	60	WCM. 06T308	174,00 €
	ATUM 34XD2 WCM. 06T308	34	32	44	68	95	60	WCM. 06T308	174,00 €
	ATUM 35XD2 WCM. 06T308	35	32	44	70	97	60	WCM. 06T308	174,00 €
	ATUM 36XD2 WCM. 06T308	36	32	44	72	99	60	WCM. 06T308	174,00 €
	ATUM 37XD2 WCM. 06T308	37	32	44	74	101	60	WCM. 06T308	174,00 €
	ATUM 38XD2 WCM. 06T308	38	32	44	76	103	60	WCM. 06T308	174,00 €
	ATUM 39XD2 WCM. 06T308	39	32	44	78	105	60	WCM. 06T308	174,00 €
	ATUM 40XD2 WCM. 06T308	40	32	44	80	107	60	WCM. 06T308	174,00 €
	ATUM 41XD2 WCM. 06T308	41	32	44	82	109	60	WCM. 06T308	180,00 €
	ATUM 42XD2 WCM. 06T308	42	32	44	84	111	60	WCM. 06T308	180,00 €
	ATUM 43XD2 WCM. 06T308	43	32	44	86	113	60	WCM. 06T308	180,00 €
	ATUM 44XD2 WCM. 06T308	44	32	44	88	115	60	WCM. 06T308	180,00 €
	ATUM 45XD2 WCM. 080412	45	40	54	90	122	70	WCM. 080412	197,00 €
	ATUM 46XD2 WCM. 080412	46	40	54	92	124	70	WCM. 080412	208,00 €
	ATUM 47XD2 WCM. 080412	47	40	54	94	126	70	WCM. 080412	225,00 €
	ATUM 48XD2 WCM. 080412	48	40	54	96	128	70	WCM. 080412	237,00 €
	ATUM 49XD2 WCM. 080412	49	40	54	98	130	70	WCM. 080412	248,00 €
	ATUM 50XD2 WCM. 080412	50	40	54	100	132	70	WCM. 080412	259,00 €
	ATUM 51XD2 WCM. 080412	51	40	54	102	134	70	WCM. 080412	270,00 €
	ATUM 52XD2 WCM. 080412	52	40	54	104	136	70	WCM. 080412	282,00 €
	ATUM 53XD2 WCM. 080412	53	40	54	106	138	70	WCM. 080412	293,00 €
	ATUM 54XD2 WCM. 080412	54	40	54	108	140	70	WCM. 080412	304,00 €
	ATUM 55XD2 WCM. 080412	55	40	54	110	142	70	WCM. 080412	304,00 €
	ATUM 56XD2 WCM. 080412	56	40	59	112	144	70	WCM. 080412	304,00 €
	ATUM 57XD2 WCM. 080412	57	40	59	114	146	70	WCM. 080412	326,00 €
	ATUM 58XD2 WCM. 080412	58	40	59	116	148	70	WCM. 080412	326,00 €
	ATUM 59XD2 WCM. 080412	59	40	59	118	150	70	WCM. 080412	326,00 €
	ATUM 60XD2 WCM. 080412	60	40	59	120	152	70	WCM. 080412	326,00 €

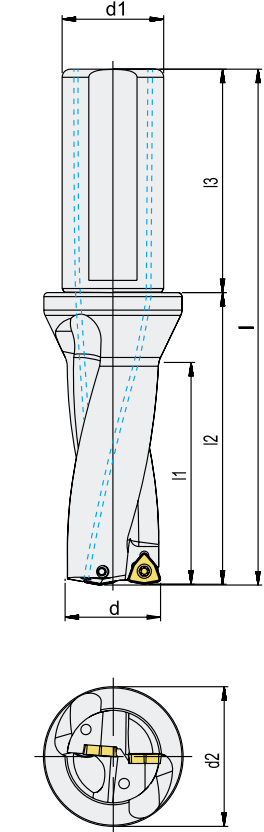

COMPATIBLE WITH ISO INSERT  
KOMPATIBEL FÜR WENDESCHNEIDPLATTEN ISO



U-DRILL SYSTEM / VOLLBOHRER (WCM.)

D3	CODE / TYP	TOOL DIMENSIONS (mm) <small>MAS</small>						CUTTING INSERT WENDE PLATTE	PRICE / PREIS
		d	d1	d2	l1	l2	l3		
	ATUM 16XD3 WCM. 030208	16	25	34	48	70	56	WCM. 030208	157,00 €
	ATUM 16.5XD3 WCM. 030208	16.5	25	34	48	70	56	WCM. 030208	157,00 €
	ATUM 17XD3 WCM. 030208	17	25	34	51	73	56	WCM. 030208	157,00 €
	ATUM 17.5XD3 WCM. 030208	17.5	25	34	51	73	56	WCM. 030208	157,00 €
	ATUM 18XD3 WCM. 030208	18	25	34	54	76	56	WCM. 030208	157,00 €
	ATUM 18.5XD3 WCM. 030208	18.5	25	34	54	76	56	WCM. 030208	157,00 €
	ATUM 19XD3 WCM. 030208	19	25	34	57	79	56	WCM. 030208	157,00 €
	ATUM 19.5XD3 WCM. 030208	19.5	25	34	57	79	56	WCM. 030208	157,00 €
	ATUM 20XD3 WCM. 040208	20	25	34	60	82	56	WCM. 040208	163,00 €
	ATUM 20.5XD3 WCM. 040208	20.5	25	34	60	82	56	WCM. 040208	163,00 €
	ATUM 21XD3 WCM. 040208	21	25	34	63	85	56	WCM. 040208	163,00 €
	ATUM 21.5XD3 WCM. 040208	21.5	25	34	63	85	56	WCM. 040208	163,00 €
	ATUM 22XD3 WCM. 040208	22	25	34	66	88	56	WCM. 040208	163,00 €
	ATUM 22.5XD3 WCM. 040208	22.5	25	34	66	88	56	WCM. 040208	163,00 €
	ATUM 23XD3 WCM. 040208	23	25	34	69	91	56	WCM. 040208	163,00 €
	ATUM 23.5XD3 WCM. 040208	23.5	25	34	69	91	56	WCM. 040208	163,00 €
	ATUM 24XD3 WCM. 050308	24	25	34	72	94	56	WCM. 050308	169,00 €
	ATUM 24.5XD3 WCM. 050308	24.5	25	34	72	94	56	WCM. 050308	169,00 €
	ATUM 25XD3 WCM. 050308	25	25	34	75	97	56	WCM. 050308	169,00 €
	ATUM 25.5XD3 WCM. 050308	25.5	25	34	75	97	56	WCM. 050308	169,00 €
	ATUM 26XD3 WCM. 050308	26	25	34	78	100	56	WCM. 050308	169,00 €
	ATUM 26.5XD3 WCM. 050308	26.5	25	34	78	100	56	WCM. 050308	169,00 €
	ATUM 27XD3 WCM. 050308	27	25	34	81	103	56	WCM. 050308	169,00 €
	ATUM 27.5XD3 WCM. 050308	27.5	25	34	81	103	56	WCM. 050308	169,00 €
	ATUM 28XD3 WCM. 050308	28	25	34	84	106	56	WCM. 050308	169,00 €
	ATUM 28.5XD3 WCM. 050308	28.5	25	34	84	106	56	WCM. 050308	169,00 €
	ATUM 29XD3 WCM. 050308	29	25	34	87	109	56	WCM. 050308	169,00 €
	ATUM 29.5XD3 WCM. 050308	29.5	25	34	87	109	56	WCM. 050308	169,00 €
	ATUM 30XD3 WCM. 06T308	30	32	44	90	117	60	WCM. 06T308	174,00 €
	ATUM 30.5XD3 WCM. 06T308	30.5	32	44	90	117	60	WCM. 06T308	174,00 €
	ATUM 31XD3 WCM. 06T308	31	32	44	93	120	60	WCM. 06T308	174,00 €
	ATUM 31.5XD3 WCM. 06T308	31.5	32	44	93	120	60	WCM. 06T308	174,00 €
	ATUM 32XD3 WCM. 06T308	32	32	44	96	123	60	WCM. 06T308	174,00 €
	ATUM 32.5XD3 WCM. 06T308	32.5	32	44	96	123	60	WCM. 06T308	174,00 €
	ATUM 33XD3 WCM. 06T308	33	32	44	99	126	60	WCM. 06T308	174,00 €
	ATUM 33.5XD3 WCM. 06T308	33.5	32	44	99	126	60	WCM. 06T308	174,00 €
	ATUM 34XD3 WCM. 06T308	34	32	44	102	129	60	WCM. 06T308	174,00 €
	ATUM 34.5XD3 WCM. 06T308	34.5	32	44	102	129	60	WCM. 06T308	174,00 €
	ATUM 35XD3 WCM. 06T308	35	32	44	105	132	60	WCM. 06T308	174,00 €
	ATUM 35.5XD3 WCM. 06T308	35.5	32	44	105	132	60	WCM. 06T308	174,00 €
	ATUM 36XD3 WCM. 06T308	36	32	44	108	135	60	WCM. 06T308	174,00 €
	ATUM 36.5XD3 WCM. 06T308	36.5	32	44	108	135	60	WCM. 06T308	174,00 €
	ATUM 37XD3 WCM. 06T308	37	32	44	111	138	60	WCM. 06T308	174,00 €
	ATUM 37.5XD3 WCM. 06T308	37.5	32	44	111	138	60	WCM. 06T308	174,00 €
	ATUM 38XD3 WCM. 06T308	38	32	44	114	141	60	WCM. 06T308	174,00 €
	ATUM 38.5XD3 WCM. 06T308	38.5	32	44	114	141	60	WCM. 06T308	174,00 €
	ATUM 39XD3 WCM. 06T308	39	32	44	117	144	60	WCM. 06T308	174,00 €
	ATUM 39.5XD3 WCM. 06T308	39.5	32	44	117	144	60	WCM. 06T308	174,00 €
	ATUM 40XD3 WCM. 06T308	40	32	44	120	147	60	WCM. 06T308	174,00 €
	ATUM 40.5XD3 WCM. 06T308	40.5	32	44	120	147	60	WCM. 06T308	174,00 €
	ATUM 41XD3 WCM. 06T308	41	32	44	123	150	60	WCM. 06T308	192,00 €
	ATUM 41.5XD3 WCM. 06T308	41.5	32	44	123	150	60	WCM. 06T308	192,00 €
	ATUM 42XD3 WCM. 06T308	42	32	44	126	153	60	WCM. 06T308	192,00 €
	ATUM 42.5XD3 WCM. 06T308	42.5	32	44	126	153	60	WCM. 06T308	192,00 €
	ATUM 43XD3 WCM. 06T308	43	32	44	129	156	60	WCM. 06T308	192,00 €
	ATUM 43.5XD3 WCM. 06T308	43.5	32	44	129	156	60	WCM. 06T308	192,00 €
	ATUM 44XD3 WCM. 06T308	44	32	44	132	159	60	WCM. 06T308	192,00 €
	ATUM 44.5XD3 WCM. 06T308	44.5	32	44	132	159	60	WCM. 06T308	192,00 €

D3

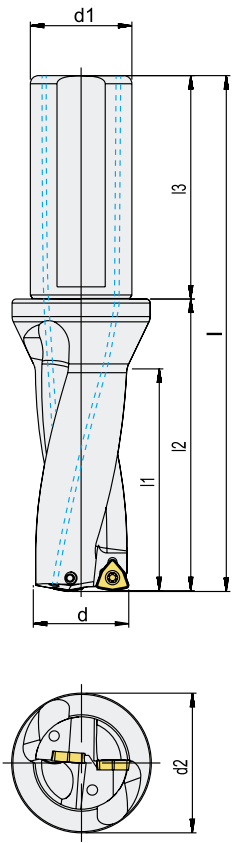

COMPATIBLE WITH ISO INSERT  
KOMPATIBEL FÜR WENDESCHNEIDPLATTEN ISO

**U-DRILL SYSTEM / VOLLBOHRER (WCM.)**

	CODE / TYP	TOOL DIMENSIONS (mm) <i>MAß</i>						CUTTING INSERT WENDE PLATTE	PRICE / PREIS
		d	d <sub>1</sub>	d <sub>2</sub>	l <sub>1</sub>	l <sub>2</sub>	l <sub>3</sub>		
<b>D3</b>  COMPATIBLE WITH ISO INSERT KOMPATIBEL FÜR WENDESCHNEIDPLATTEN ISO	ATUM 45XD3 WCM. 080412	45	40	54	135	167	70	WCM. 080412	202,00 €
	ATUM 45.5XD3 WCM. 080412	45.5	40	54	135	167	70	WCM. 080412	214,00 €
	ATUM 46XD3 WCM. 080412	46	40	54	138	170	70	WCM. 080412	225,00 €
	ATUM 47XD3 WCM. 080412	47	40	54	141	173	70	WCM. 080412	237,00 €
	ATUM 48XD3 WCM. 080412	48	40	54	144	176	70	WCM. 080412	248,00 €
	ATUM 49XD3 WCM. 080412	49	40	54	147	179	70	WCM. 080412	270,00 €
	ATUM 50XD3 WCM. 080412	50	40	54	150	182	70	WCM. 080412	282,00 €
	ATUM 51XD3 WCM. 080412	51	40	54	153	185	70	WCM. 080412	293,00 €
	ATUM 52XD3 WCM. 080412	52	40	54	156	188	70	WCM. 080412	304,00 €
	ATUM 53XD3 WCM. 080412	53	40	54	159	191	70	WCM. 080412	315,00 €
	ATUM 54XD3 WCM. 080412	54	40	54	162	194	70	WCM. 080412	315,00 €
	ATUM 55XD3 WCM. 080412	55	40	54	165	197	70	WCM. 080412	315,00 €
	ATUM 56XD3 WCM. 080412	56	40	59	168	200	70	WCM. 080412	338,00 €
	ATUM 57XD3 WCM. 080412	57	40	59	171	203	70	WCM. 080412	338,00 €
	ATUM 58XD3 WCM. 080412	58	40	59	174	206	70	WCM. 080412	338,00 €
ATUM 59XD3 WCM. 080412	59	40	59	177	209	70	WCM. 080412	338,00 €	
ATUM 60XD3 WCM. 080412	60	40	59	180	212	70	WCM. 080412	338,00 €	

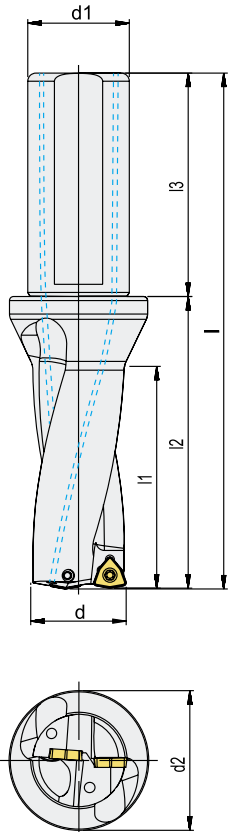
	CODE / TYP	TOOL DIMENSIONS (mm) <i>MAß</i>						CUTTING INSERT WENDE PLATTE	PRICE / PREIS
		d	d <sub>1</sub>	d <sub>2</sub>	l <sub>1</sub>	l <sub>2</sub>	l <sub>3</sub>		
<b>D4</b>   COMPATIBLE WITH ISO INSERT KOMPATIBEL FÜR WENDESCHNEIDPLATTEN ISO	ATUM 16XD4 WCM. 030208	16	25	34	64	86	56	WCM. 030208	259,00 €
	ATUM 17XD4 WCM. 030208	17	25	34	68	90	56	WCM. 030208	259,00 €
	ATUM 18XD4 WCM. 030208	18	25	34	72	94	56	WCM. 030208	259,00 €
	ATUM 19XD4 WCM. 030208	19	25	34	76	98	56	WCM. 030208	259,00 €
	ATUM 20XD4 WCM. 040208	20	25	34	80	102	56	WCM. 040208	270,00 €
	ATUM 21XD4 WCM. 040208	21	25	34	84	106	56	WCM. 040208	270,00 €
	ATUM 22XD4 WCM. 040208	22	25	34	88	110	56	WCM. 040208	270,00 €
	ATUM 23XD4 WCM. 040208	23	25	34	92	114	56	WCM. 040208	270,00 €
	ATUM 24XD4 WCM. 050308	24	25	34	96	118	56	WCM. 050308	282,00 €
	ATUM 25XD4 WCM. 050308	25	25	34	100	122	56	WCM. 050308	282,00 €
	ATUM 26XD4 WCM. 050308	26	25	34	104	126	56	WCM. 050308	282,00 €
	ATUM 27XD4 WCM. 050308	27	25	34	108	130	56	WCM. 050308	282,00 €
	ATUM 28XD4 WCM. 050308	28	25	34	112	134	56	WCM. 050308	282,00 €
	ATUM 29XD4 WCM. 050308	29	25	34	116	138	56	WCM. 050308	282,00 €
	ATUM 30XD4 WCM. 06T308	30	32	44	120	147	60	WCM. 06T308	293,00 €
	ATUM 31XD4 WCM. 06T308	31	32	44	124	151	60	WCM. 06T308	293,00 €
	ATUM 32XD4 WCM. 06T308	32	32	44	128	155	60	WCM. 06T308	293,00 €
	ATUM 33XD4 WCM. 06T308	33	32	44	132	159	60	WCM. 06T308	293,00 €
	ATUM 33.5XD4 WCM. 06T308	33.5	32	44	132	159	60	WCM. 06T308	293,00 €
	ATUM 34XD4 WCM. 06T308	34	32	44	136	163	60	WCM. 06T308	293,00 €
	ATUM 35XD4 WCM. 06T308	35	32	44	140	167	60	WCM. 06T308	293,00 €
	ATUM 36XD4 WCM. 06T308	36	32	44	144	171	60	WCM. 06T308	293,00 €
	ATUM 37XD4 WCM. 06T308	37	32	44	148	175	60	WCM. 06T308	293,00 €
	ATUM 38XD4 WCM. 06T308	38	32	44	152	179	60	WCM. 06T308	293,00 €
	ATUM 38.5XD4 WCM. 06T308	38.5	32	44	152	179	60	WCM. 06T308	293,00 €
	ATUM 39XD4 WCM. 06T308	39	32	44	156	183	60	WCM. 06T308	293,00 €
	ATUM 40XD4 WCM. 06T308	40	32	44	160	187	60	WCM. 06T308	293,00 €
	ATUM 41XD4 WCM. 06T308	41	32	44	164	191	60	WCM. 06T308	315,00 €
	ATUM 42XD4 WCM. 06T308	42	32	44	168	195	60	WCM. 06T308	315,00 €
	ATUM 43XD4 WCM. 06T308	43	32	44	172	199	60	WCM. 06T308	315,00 €
	ATUM 44XD4 WCM. 06T308	44	32	44	176	203	60	WCM. 06T308	315,00 €
	ATUM 45XD4 WCM. 080412	45	40	54	180	212	70	WCM. 080412	338,00 €
ATUM 46XD4 WCM. 080412	46	40	54	184	216	70	WCM. 080412	360,00 €	
ATUM 47XD4 WCM. 080412	47	40	54	188	220	70	WCM. 080412	383,00 €	
ATUM 48XD4 WCM. 080412	48	40	54	192	224	70	WCM. 080412	405,00 €	
ATUM 49XD4 WCM. 080412	49	40	54	196	228	70	WCM. 080412	427,00 €	
ATUM 50XD4 WCM. 080412	50	40	54	200	232	70	WCM. 080412	450,00 €	



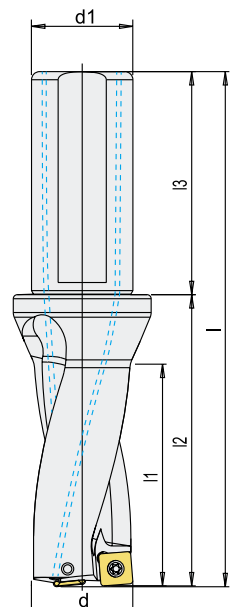
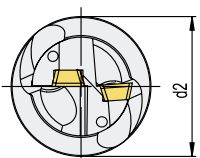

## U-DRILL SYSTEM / VOLLBOHRER (SPMG)

	CODE / TYP	TOOL DIMENSIONS (mm) <small>MAS</small>						CUTTING INSERT WENDE PLATTE	PRICE / PREIS
		d	d <sub>1</sub>	d <sub>2</sub>	l <sub>1</sub>	l <sub>2</sub>	l <sub>3</sub>		
<b>D3</b>     	ATUM 12.5XD3 SP.. 050204	12,5	20	25	36	58	50	SP.. 050204	157,00 €
	ATUM 13XD3 SP.. 050204	13	20	25	39	61	50	SP.. 050204	157,00 €
	ATUM 13.5XD3 SP.. 050204	13,5	20	25	39	61	50	SP.. 050204	157,00 €
	ATUM 14XD3 SP.. 050204	14	20	25	42	64	50	SP.. 050204	157,00 €
	ATUM 14.5XD3 SP.. 050204	14,5	20	25	42	64	50	SP.. 050204	157,00 €
	ATUM 15XD3 SP.. 050204	15	20	25	45	67	50	SP.. 050204	157,00 €
	ATUM 15.5XD3 SP.. 060204	15,5	20	25	45	67	50	SP.. 060204	157,00 €
	ATUM 16XD3 SP.. 060204	16	25	34	48	70	56	SP.. 060204	157,00 €
	ATUM 16.5XD3 SP.. 060204	16,5	25	34	48	70	56	SP.. 060204	157,00 €
	ATUM 17XD3 SP.. 060204	17	25	34	51	73	56	SP.. 060204	157,00 €
	ATUM 17.5XD3 SP.. 060204	17,5	25	34	51	73	56	SP.. 060204	157,00 €
	ATUM 18XD3 SP.. 060204	18	25	34	54	76	56	SP.. 060204	157,00 €
	ATUM 18.5XD3 SP.. 060204	18,5	25	34	54	76	56	SP.. 060204	157,00 €
	ATUM 19xD3 SP.. 060204	19	25	34	57	79	56	SP.. 060204	157,00 €
	ATUM 19.5XD3 SP.. 060204	19,5	25	34	57	79	56	SP.. 060204	157,00 €
	ATUM 20XD3 SP.. 060204	20	25	34	60	82	56	SP.. 060204	163,00 €
	ATUM 20.5XD3 SP.. 060204	20,5	25	34	60	82	56	SP.. 060204	163,00 €
	ATUM 21XD3 SP.. 060204	21	25	34	63	85	56	SP.. 060204	163,00 €
	ATUM 21.5XD3 SP.. 060204	21,5	25	34	63	85	56	SP.. 060204	163,00 €
	ATUM 22XD3 SP.. 07T308	22	25	34	66	88	56	SP.. 07T308	163,00 €
	ATUM 22.5XD3 SP.. 07T308	22,5	25	34	66	88	56	SP.. 07T308	163,00 €
	ATUM 23XD3 SP.. 07T308	23	25	34	69	91	56	SP.. 07T308	163,00 €
	ATUM 23.5XD3 SP.. 07T308	23,5	25	34	69	91	56	SP.. 07T308	163,00 €
	ATUM 24XD3 SP.. 07T308	24	25	34	72	94	56	SP.. 07T308	169,00 €
	ATUM 24.5XD3 SP.. 07T308	24,5	25	34	72	94	56	SP.. 07T308	169,00 €
	ATUM 25XD3 SP.. 07T308	25	25	34	75	97	56	SP.. 07T308	169,00 €
	ATUM 25.5XD3 SP.. 07T308	25,5	25	34	75	97	56	SP.. 07T308	169,00 €
	ATUM 26XD3 SP.. 07T308	26	25	34	78	100	56	SP.. 07T308	169,00 €
	ATUM 26.5XD3 SP.. 07T308	26,5	25	34	78	100	56	SP.. 07T308	169,00 €
	ATUM 27XD3 SP.. 07T308	27	25	34	81	103	56	SP.. 07T308	169,00 €
	ATUM 27.5XD3 SP.. 07T308	27,5	25	34	81	103	56	SP.. 07T308	169,00 €
	ATUM 28XD3 SP.. 090408	28	25	34	84	106	56	SP.. 090408	169,00 €
	ATUM 28.5XD3 SP.. 090408	28,5	25	34	84	106	56	SP.. 090408	169,00 €
	ATUM 29XD3 SP.. 090408	29	25	34	87	109	56	SP.. 090408	169,00 €
	ATUM 29.5XD3 SP.. 090408	29,5	25	34	87	109	56	SP.. 090408	169,00 €
	ATUM 30XD3 SP.. 090408	30	32	44	90	117	60	SP.. 090408	174,00 €
	ATUM 30.5XD3 SP.. 090408	30,5	32	44	90	117	60	SP.. 090408	174,00 €
	ATUM 31XD3 SP.. 090408	31	32	44	93	120	60	SP.. 090408	174,00 €
	ATUM 31.5XD3 SP.. 090408	31,5	32	44	93	120	60	SP.. 090408	174,00 €
	ATUM 32XD3 SP.. 090408	32	32	44	96	123	60	SP.. 090408	174,00 €
	ATUM 32.5XD3 SP.. 090408	32,5	32	44	96	123	60	SP.. 090408	174,00 €
	ATUM 33XD3 SP.. 090408	33	32	44	99	126	60	SP.. 090408	174,00 €
	ATUM 33.5XD3 SP.. 090408	33,5	32	44	99	126	60	SP.. 090408	174,00 €
	ATUM 34XD3 SP.. 110408	34	32	44	102	129	60	SP.. 110408	174,00 €
	ATUM 34.5XD3 SP.. 110408	34,5	32	44	102	129	60	SP.. 110408	174,00 €
ATUM 35XD3 SP.. 110408	35	32	44	105	132	60	SP.. 110408	174,00 €	
ATUM 35.5XD3 SP.. 110408	35,5	32	44	105	132	60	SP.. 110408	174,00 €	
ATUM 36XD3 SP.. 110408	36	32	44	108	135	60	SP.. 110408	174,00 €	
ATUM 36.5XD3 SP.. 110408	36,5	32	44	108	135	60	SP.. 110408	174,00 €	
ATUM 37XD3 SP.. 110408	37	32	44	111	138	60	SP.. 110408	174,00 €	
ATUM 37.5XD3 SP.. 110408	37,5	32	44	111	138	60	SP.. 110408	174,00 €	
ATUM 38XD3 SP.. 110408	38	32	44	114	141	60	SP.. 110408	174,00 €	
ATUM 38.5XD3 SP.. 110408	38,5	32	44	114	141	60	SP.. 110408	174,00 €	
ATUM 39XD3 SP.. 110408	39	32	44	117	144	60	SP.. 110408	174,00 €	
ATUM 39.5XD3 SP.. 110408	39,5	32	44	117	144	60	SP.. 110408	174,00 €	
ATUM 40XD3 SP.. 110408	40	32	44	120	147	60	SP.. 110408	174,00 €	
ATUM 40.5XD3 SP.. 110408	40,5	32	44	120	147	60	SP.. 110408	174,00 €	
ATUM 41XD3 SP.. 110408	41	32	44	123	150	60	SP.. 110408	192,00 €	
ATUM 41.5XD3 SP.. 110408	41,5	32	44	123	150	60	SP.. 110408	192,00 €	
ATUM 42XD3 SP.. 140512	42	32	44	126	153	60	SP.. 140512	192,00 €	
ATUM 42.5XD3 SP.. 140512	42,5	32	44	126	153	60	SP.. 140512	192,00 €	

COMPATIBLE WITH TGTC INSERT  
KOMPATIBEL FÜR WENDESCHNEIDPLATTEN TGTC

**U-DRILL SYSTEM / VOLLBOHRER (SPMG)**

	CODE / TYP	TOOL DIMENSIONS (mm) <i>MAB</i>						CUTTING INSERT WENDE PLATTE	PRICE / PREIS
		d	d <sub>1</sub>	d <sub>2</sub>	l <sub>1</sub>	l <sub>2</sub>	l <sub>3</sub>		
<b>D3</b> 	ATUM 43XD3 SP.. 140512	43	32	44	129	156	60	SP.. 140512	192,00 €
	ATUM 43.5XD3 SP.. 140512	43.5	32	44	129	156	60	SP.. 140512	192,00 €
	ATUM 44XD3 SP.. 140512	44	32	44	132	159	60	SP.. 140512	192,00 €
	ATUM 44.5XD3 SP.. 140512	44.5	32	44	132	159	60	SP.. 140512	192,00 €
	ATUM 45XD3 SP.. 140512	45	40	54	135	167	70	SP.. 140512	202,00 €
	ATUM 45.5XD3 SP.. 140512	45.5	40	54	135	167	70	SP.. 140512	202,00 €
	ATUM 46XD3 SP.. 140512	46	40	54	138	170	70	SP.. 140512	214,00 €
	ATUM 47XD3 SP.. 140512	47	40	54	141	173	70	SP.. 140512	225,00 €
	ATUM 48XD3 SP.. 140512	48	40	54	144	176	70	SP.. 140512	237,00 €
	ATUM 49XD3 SP.. 140512	49	40	54	147	179	70	SP.. 140512	248,00 €
	ATUM 50XD3 SP.. 140512	50	40	54	150	182	70	SP.. 140512	270,00 €
	ATUM 51XD3 SP.. 140512	51	40	54	153	185	70	SP.. 140512	282,00 €
	ATUM 52XD3 SP.. 140512	52	40	54	156	188	70	SP.. 140512	293,00 €
COMPATIBLE WITH TGTC INSERT KOMPATIBEL FÜR WENDESCHNEIDPLATTEN TGTC									

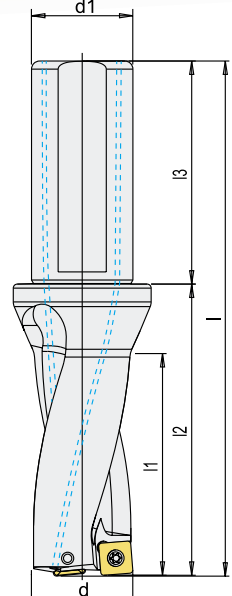
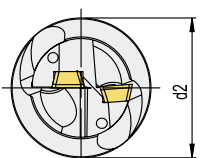
	CODE / TYP	TOOL DIMENSIONS (mm) <i>MAB</i>						CUTTING INSERT WENDE PLATTE	PRICE / PREIS
		d	d <sub>1</sub>	d <sub>2</sub>	l <sub>1</sub>	l <sub>2</sub>	l <sub>3</sub>		
<b>D4</b>   	ATUM 13XD4 SP.. 050204	13	20	25	52	74	50	SP.. 050204	259,00 €
	ATUM 14XD4 SP.. 050204	14	20	25	56	78	50	SP.. 050204	259,00 €
	ATUM 15XD4 SP.. 050204	15	20	25	60	82	50	SP.. 050204	259,00 €
	ATUM 16XD4 SP.. 060204	16	25	34	64	86	56	SP.. 060204	259,00 €
	ATUM 17XD4 SP.. 060204	17	25	34	68	90	56	SP.. 060204	259,00 €
	ATUM 17.5XD4 SP.. 060204	17.5	25	34	68	90	56	SP.. 060204	259,00 €
	ATUM 18XD4 SP.. 060204	18	25	34	72	94	56	SP.. 060204	259,00 €
	ATUM 19XD4 SP.. 060204	19	25	34	76	98	56	SP.. 060204	259,00 €
	ATUM 19.5XD4 SP.. 060204	19.5	25	34	76	98	56	SP.. 060204	259,00 €
	ATUM 20XD4 SP.. 060204	20	25	34	80	102	56	SP.. 060204	270,00 €
	ATUM 21XD4 SP.. 060204	21	25	34	84	106	56	SP.. 060204	270,00 €
	ATUM 22XD4 SP.. 07T308	22	25	34	88	110	56	SP.. 07T308	270,00 €
	ATUM 23XD4 SP.. 07T308	23	25	34	92	114	56	SP.. 07T308	270,00 €
	ATUM 23.5XD4 SP.. 07T308	23.5	25	34	92	114	56	SP.. 07T308	270,00 €
	ATUM 24XD4 SP.. 07T308	24	25	34	96	118	56	SP.. 07T308	282,00 €
	ATUM 25XD4 SP.. 07T308	25	25	34	100	122	56	SP.. 07T308	282,00 €
	ATUM 26XD4 SP.. 07T308	26	25	34	104	126	56	SP.. 07T308	282,00 €
	ATUM 27XD4 SP.. 07T308	27	25	34	108	130	56	SP.. 07T308	282,00 €
	ATUM 27.5XD4 SP.. 07T308	27.5	25	34	108	130	56	SP.. 07T308	282,00 €
	ATUM 28XD4 SP.. 090408	28	25	34	112	134	56	SP.. 090408	282,00 €
	ATUM 29XD4 SP.. 090408	29	25	34	116	138	56	SP.. 090408	282,00 €
	ATUM 30XD4 SP.. 090408	30	32	44	120	147	60	SP.. 090408	293,00 €
	ATUM 31XD4 SP.. 090408	31	32	44	124	151	60	SP.. 090408	293,00 €
	ATUM 32XD4 SP.. 090408	32	32	44	128	155	60	SP.. 090408	293,00 €
	ATUM 33XD4 SP.. 090408	33	32	44	132	159	60	SP.. 090408	293,00 €
	ATUM 33.5XD4 SP.. 090408	33.5	32	44	132	159	60	SP.. 090408	293,00 €
	ATUM 34XD4 SP.. 110408	34	32	44	136	163	60	SP.. 110408	293,00 €
	ATUM 35XD4 SP.. 110408	35	32	44	140	167	60	SP.. 110408	293,00 €
	ATUM 36XD4 SP.. 110408	36	32	44	144	171	60	SP.. 110408	293,00 €
	ATUM 37XD4 SP.. 110408	37	32	44	148	175	60	SP.. 110408	293,00 €
	ATUM 38XD4 SP.. 110408	38	32	44	152	179	60	SP.. 110408	293,00 €
	ATUM 39XD4 SP.. 110408	39	32	44	156	183	60	SP.. 110408	293,00 €
	ATUM 40XD4 SP.. 110408	40	32	44	160	187	60	SP.. 110408	293,00 €
ATUM 41XD4 SP.. 110408	41	32	44	164	191	60	SP.. 110408	315,00 €	
ATUM 42XD4 SP.. 140512	42	32	44	168	195	60	SP.. 140512	315,00 €	
ATUM 43XD4 SP.. 140512	43	32	44	172	199	60	SP.. 140512	315,00 €	
ATUM 44XD4 SP.. 140512	44	32	44	176	203	60	SP.. 140512	315,00 €	
COMPATIBLE WITH TGTC INSERT KOMPATIBEL FÜR WENDESCHNEIDPLATTEN TGTC									

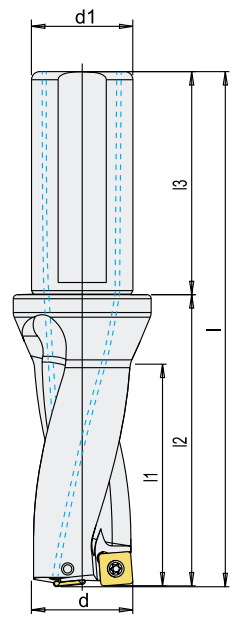
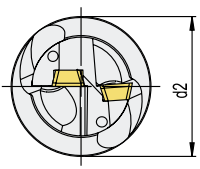

U-DRILL SYSTEM / VOLLBOHRER (SPGT)

	CODE / TYP	TOOL DIMENSIONS (mm) <small>MAß</small>						CUTTING INSERT WENDE PLATTE	PRICE / PREIS
		d	d <sub>1</sub>	d <sub>2</sub>	l <sub>1</sub>	l <sub>2</sub>	l <sub>3</sub>		
<p><b>D3</b></p>   	ATUM 12.5XD3 SPGT 050204	12,5	20	25	36	58	50	SPGT 050204	157,00 €
	ATUM 13XD3 SPGT 050204	13	20	25	39	61	50	SPGT 050204	157,00 €
	ATUM 13.5XD3 SPGT 050204	13,5	20	25	39	61	50	SPGT 050204	157,00 €
	ATUM 14XD3 SPGT 050204	14	20	25	42	64	50	SPGT 050204	157,00 €
	ATUM 14.5XD3 SPGT 050204	14,5	20	25	42	64	50	SPGT 050204	157,00 €
	ATUM 15XD3 SPGT 050204	15	20	25	45	67	50	SPGT 050204	157,00 €
	ATUM 15.5XD3 SPGT 060204	15,5	20	25	45	67	50	SPGT 060204	157,00 €
	ATUM 16XD3 SPGT 060204	16	25	34	48	70	56	SPGT 060204	157,00 €
	ATUM 16.5XD3 SPGT 060204	16,5	25	34	48	70	56	SPGT 060204	157,00 €
	ATUM 17XD3 SPGT 060204	17	25	34	51	73	56	SPGT 060204	157,00 €
	ATUM 17.5XD3 SPGT 060204	17,5	25	34	51	73	56	SPGT 060204	157,00 €
	ATUM 18XD3 SPGT 060204	18	25	34	54	76	56	SPGT 060204	157,00 €
	ATUM 18.5XD3 SPGT 060204	18,5	25	34	54	76	56	SPGT 060204	157,00 €
	ATUM 19XD3 SPGT 060204	19	25	34	57	79	56	SPGT 060204	157,00 €
	ATUM 19.5XD3 SPGT 060204	19,5	25	34	57	79	56	SPGT 060204	157,00 €
	ATUM 20XD3 SPGT 060204	20	25	34	60	82	56	SPGT 060204	163,00 €
	ATUM 20.5XD3 SPGT 060204	20,5	25	34	60	82	56	SPGT 060204	163,00 €
	ATUM 21XD3 SPGT 060204	21	25	34	63	85	56	SPGT 060204	163,00 €
	ATUM 21.5XD3 SPGT 060204	21,5	25	34	63	85	56	SPGT 060204	163,00 €
	ATUM 22XD3 SPGT 07T308	22	25	34	66	88	56	SPGT 07T308	163,00 €
	ATUM 22.5XD3 SPGT 07T308	22,5	25	34	66	88	56	SPGT 07T308	163,00 €
	ATUM 23XD3 SPGT 07T308	23	25	34	69	91	56	SPGT 07T308	163,00 €
	ATUM 23.5XD3 SPGT 07T308	23,5	25	34	69	91	56	SPGT 07T308	163,00 €
	ATUM 24XD3 SPGT 07T308	24	25	34	72	94	56	SPGT 07T308	169,00 €
	ATUM 24.5XD3 SPGT 07T308	24,5	25	34	72	94	56	SPGT 07T308	169,00 €
	ATUM 25XD3 SPGT 07T308	25	25	34	75	97	56	SPGT 07T308	169,00 €
	ATUM 25.5XD3 SPGT 07T308	25,5	25	34	75	97	56	SPGT 07T308	169,00 €
	ATUM 26XD3 SPGT 07T308	26	25	34	78	100	56	SPGT 07T308	169,00 €
	ATUM 26.5XD3 SPGT 07T308	26,5	25	34	78	100	56	SPGT 07T308	169,00 €
	ATUM 27XD3 SPGT 07T308	27	25	34	81	103	56	SPGT 07T308	169,00 €
	ATUM 27.5XD3 SPGT 07T308	27,5	25	34	81	103	56	SPGT 07T308	169,00 €
	ATUM 28XD3 SPGT 090408	28	25	34	84	106	56	SPGT 090408	169,00 €
	ATUM 28.5XD3 SPGT 090408	28,5	25	34	84	106	56	SPGT 090408	169,00 €
	ATUM 29XD3 SPGT 090408	29	25	34	87	109	56	SPGT 090408	169,00 €
	ATUM 29.5XD3 SPGT 090408	29,5	25	34	87	109	56	SPGT 090408	169,00 €
	ATUM 30XD3 SPGT 090408	30	32	44	90	117	60	SPGT 090408	174,00 €
	ATUM 31XD3 SPGT 090408	31	32	44	93	120	60	SPGT 090408	174,00 €
	ATUM 32XD3 SPGT 090408	32	32	44	96	123	60	SPGT 090408	174,00 €
	ATUM 33XD3 SPGT 090408	33	32	44	99	126	60	SPGT 090408	174,00 €
	ATUM 34XD3 SPGT 110408	34	32	44	102	129	60	SPGT 110408	174,00 €
	ATUM 35XD3 SPGT 110408	35	32	44	105	132	60	SPGT 110408	174,00 €
	ATUM 37XD3 SPGT 110408	37	32	44	111	138	60	SPGT 110408	174,00 €
	ATUM 38XD3 SPGT 110408	38	32	44	114	141	60	SPGT 110408	174,00 €
	ATUM 39XD3 SPGT 110408	39	32	44	117	144	60	SPGT 110408	174,00 €
	ATUM 40XD3 SPGT 110408	40	32	44	120	147	60	SPGT 110408	174,00 €
	ATUM 42XD3 SPGT 140512	42	32	44	126	153	60	SPGT 140512	192,00 €
	ATUM 43XD3 SPGT 140512	43	32	44	129	156	60	SPGT 140512	192,00 €
	ATUM 44XD3 SPGT 140512	44	32	44	132	159	60	SPGT 140512	192,00 €
	ATUM 49XD3 SPGT 140512	49	40	54	147	179	70	SPGT 140512	248,00 €
	ATUM 50XD3 SPGT 140512	50	40	54	150	182	70	SPGT 140512	270,00 €

COMPATIBLE WITH ZCC INSERT  
KOMPATIBEL FÜR WENDESCHNEIDPLATTEN ZCC







## U-DRILL SYSTEM / VOLLBOHRER (SPMT - XOMT)



	CODE / TYP	TOOL DIMENSIONS (mm) MAß							CUTTING INSERT WENDE PLATTE	PRICE / PREIS
		d	d <sub>1</sub>	d <sub>2</sub>	l	l <sub>1</sub>	l <sub>2</sub>	l <sub>3</sub>		
<b>D4</b>  COMPATIBLE WITH KRLY INSERT KOMPATIBEL FÜR WENDESCHNEIDPLATTEN KRLY	ATUM 14XD4 KDR 0502..	14	20	25	128	56	78	50	SPMT 050204-XOMT 050204	259,00 €
	ATUM 14.5XD4 KDR 0502..	14.5	20	25	128	56	78	50	SPMT 050204-XOMT 050204	259,00 €
	ATUM 15XD4 KDR 0502..	15	20	25	132	60	82	50	SPMT 050204-XOMT 050204	259,00 €
	ATUM 15.5XD4 KDR 0502..	15.5	20	25	132	60	82	50	SPMT 050204-XOMT 050204	259,00 €
	ATUM 16XD4 KDR 0502..	16	25	34	142	64	86	56	SPMT 050204-XOMT 050204	259,00 €
	ATUM 17XD4 KDR 0602..	17	25	34	146	68	90	56	SPMT 060205-XOMT 060204	259,00 €
	ATUM 17.5XD4 KDR 0602..	17.5	25	34	146	68	90	56	SPMT 060205-XOMT 060204	259,00 €
	ATUM 18XD4 KDR 0602..	18	25	34	150	72	94	56	SPMT 060205-XOMT 060204	259,00 €
	ATUM 18.5XD4 KDR 0602..	18.5	25	34	150	72	94	56	SPMT 060205-XOMT 060204	259,00 €
	ATUM 19XD4 KDR 0602..	19	25	34	154	76	98	56	SPMT 060205-XOMT 060204	259,00 €
	ATUM 20XD4 KDR 07T2..	20	25	34	158	80	102	56	SPMT 07T208-XOMT 07T205	270,00 €
	ATUM 21XD4 KDR 07T2..	21	25	34	162	84	106	56	SPMT 07T208-XOMT 07T205	270,00 €
	ATUM 22XD4 KDR 07T2..	22	25	34	166	88	110	56	SPMT 07T208-XOMT 07T205	270,00 €
	ATUM 24XD4 KDR 0903..	24	25	34	174	96	118	56	SPMT 090308-XOMT 090305	282,00 €
ATUM 25XD4 KDR 0903..	25	25	34	178	100	122	56	SPMT 090308-XOMT 090305	282,00 €	



## U-DRILL SYSTEM / VOLLBOHRER (SOMT)

	CODE / TYP	TOOL DIMENSIONS (mm) MAß							CUTTING INSERT WENDE PLATTE	PRICE / PREIS
		d	d <sub>1</sub>	d <sub>2</sub>	l	l <sub>1</sub>	l <sub>2</sub>	l <sub>3</sub>		
<b>D2</b>  COMPATIBLE WITH TGTC INSERT KOMPATIBEL FÜR WENDESCHNEIDPLATTEN TGTC	ATUM 14XD2 SOMT 050204	14	20	25	100	28	50	50	SOMT 050204	147,00 €
	ATUM 16XD2 SOMT 050204	16	25	34	110	32	54	56	SOMT 050204	147,00 €
	ATUM 17XD2 SOMT 060204	17	25	34	112	34	56	56	SOMT 060204	147,00 €
	ATUM 18XD2 SOMT 060204	18	25	34	114	36	58	56	SOMT 060204	147,00 €
	ATUM 20XD2 SOMT 070306	20	25	34	118	40	62	56	SOMT 070306	157,00 €
	ATUM 22XD2 SOMT 070306	22	25	34	122	44	66	56	SOMT 070306	157,00 €
	ATUM 24XD2 SOMT 08T306	24	25	34	126	48	70	56	SOMT 08T306	163,00 €
	ATUM 25XD2 SOMT 08T306	25	25	34	128	50	72	56	SOMT 08T306	163,00 €
	ATUM 26XD2 SOMT 08T306	26	25	34	130	52	74	56	SOMT 08T306	163,00 €
	ATUM 27XD2 SOMT 09T308	27	25	34	132	54	76	56	SOMT 09T308	163,00 €
	ATUM 28XD2 SOMT 09T308	28	25	34	134	56	78	56	SOMT 09T308	163,00 €
	ATUM 30XD2 SOMT 09T308	30	32	44	147	60	87	60	SOMT 09T308	174,00 €
	ATUM 32XD2 SOMT 11T308	32	32	44	151	64	91	60	SOMT 11T308	174,00 €
	ATUM 33XD2 SOMT 11T308	33	32	44	153	66	93	60	SOMT 11T308	174,00 €
	ATUM 34XD2 SOMT 11T308	34	32	44	155	68	95	60	SOMT 11T308	174,00 €
	ATUM 35XD2 SOMT 11T308	35	32	44	157	70	97	60	SOMT 11T308	174,00 €
	ATUM 37XD2 SOMT 130408	37	32	44	161	74	101	60	SOMT 130408	174,00 €
	ATUM 38XD2 SOMT 130408	38	32	44	163	76	103	60	SOMT 130408	174,00 €
ATUM 40XD2 SOMT 130408	40	32	44	167	80	107	60	SOMT 130408	174,00 €	
ATUM 45XD2 SOMT 150510	45	40	54	192	90	122	70	SOMT 150510	197,00 €	



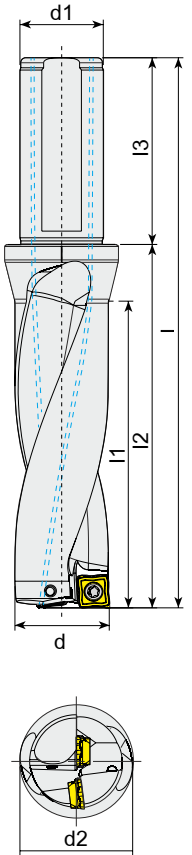

**U-DRILL SYSTEM / VOLLBOHRER (SOMT)**

	CODE / TYP	TOOL DIMENSIONS (mm) <small>MAB</small>							CUTTING INSERT WENDE PLATTE	PRICE / PREIS
		d	d <sub>1</sub>	d <sub>2</sub>	l	l <sub>1</sub>	l <sub>2</sub>	l <sub>3</sub>		
<p><b>D3</b></p>    <p>COMPATIBLE WITH TGTC INSERT KOMPATIBEL FÜR WENDESCHNEIDPLATTEN TGTC</p>	ATUM 14XD3 SOMT 050204	14	20	25	114	42	64	50	SOMT 050204	157,00 €
	ATUM 14.5XD3 SOMT 050204	14.5	20	25	114	42	64	50	SOMT 050204	157,00 €
	ATUM 15XD3 SOMT 050204	15	20	25	117	45	67	50	SOMT 050204	157,00 €
	ATUM 15.5XD3 SOMT 050204	15.5	20	25	117	45	67	50	SOMT 050204	157,00 €
	ATUM 16XD3 SOMT 050204	16	25	34	126	48	70	56	SOMT 050204	157,00 €
	ATUM 16.5XD3 SOMT 060204	16.5	25	34	126	48	70	56	SOMT 060204	157,00 €
	ATUM 17XD3 SOMT 060204	17	25	34	129	51	73	56	SOMT 060204	157,00 €
	ATUM 17.5XD3 SOMT 060204	17.5	25	34	129	51	73	56	SOMT 060204	157,00 €
	ATUM 18XD3 SOMT 060204	18	25	34	132	54	76	56	SOMT 060204	157,00 €
	ATUM 18.5XD3 SOMT 060204	18.5	25	34	132	54	76	56	SOMT 060204	157,00 €
	ATUM 19XD3 SOMT 060204	19	25	34	135	57	79	56	SOMT 060204	157,00 €
	ATUM 19.5XD3 SOMT 070306	19.5	25	34	135	57	79	56	SOMT 070306	157,00 €
	ATUM 20XD3 SOMT 070306	20	25	34	138	60	82	56	SOMT 070306	163,00 €
	ATUM 20.5XD3 SOMT 070306	20.5	25	34	138	60	82	56	SOMT 070306	163,00 €
	ATUM 21XD3 SOMT 070306	21	25	34	141	63	85	56	SOMT 070306	163,00 €
	ATUM 22XD3 SOMT 070306	22	25	34	144	66	88	56	SOMT 070306	163,00 €
	ATUM 22.5XD3 SOMT 08T306	22.5	25	34	144	66	88	56	SOMT 08T306	163,00 €
	ATUM 23XD3 SOMT 08T306	23	25	34	147	69	91	56	SOMT 08T306	163,00 €
	ATUM 23.5XD3 SOMT 08T306	23.5	25	34	147	69	91	56	SOMT 08T306	163,00 €
	ATUM 24XD3 SOMT 08T306	24	25	34	150	72	94	56	SOMT 08T306	169,00 €
	ATUM 24.5XD3 SOMT 08T306	24.5	25	34	150	72	94	56	SOMT 08T306	169,00 €
	ATUM 25XD3 SOMT 08T306	25	25	34	153	75	97	56	SOMT 08T306	169,00 €
	ATUM 26XD3 SOMT 08T306	26	25	34	156	78	100	56	SOMT 08T306	169,00 €
	ATUM 27XD3 SOMT 09T308	27	25	34	159	81	103	56	SOMT 09T308	169,00 €
	ATUM 27.5XD3 SOMT 09T308	27.5	25	34	159	81	103	56	SOMT 09T308	169,00 €
	ATUM 28XD3 SOMT 09T308	28	25	34	162	84	106	56	SOMT 09T308	169,00 €
	ATUM 29XD3 SOMT 09T308	29	25	34	165	87	109	56	SOMT 09T308	169,00 €
	ATUM 30XD3 SOMT 09T308	30	32	44	177	90	117	60	SOMT 09T308	174,00 €
	ATUM 32XD3 SOMT 11T308	32	32	44	183	96	123	60	SOMT 11T308	174,00 €
	ATUM 33XD3 SOMT 11T308	33	32	44	186	99	126	60	SOMT 11T308	174,00 €
	ATUM 34XD3 SOMT 11T308	34	32	44	189	102	129	60	SOMT 11T308	174,00 €
	ATUM 35XD3 SOMT 11T308	35	32	44	192	105	132	60	SOMT 11T308	174,00 €
	ATUM 36XD3 SOMT 11T308	36	32	44	195	108	135	60	SOMT 11T308	174,00 €
ATUM 37XD3 SOMT 130408	37	32	44	198	111	138	60	SOMT 130408	174,00 €	
ATUM 38XD3 SOMT 130408	38	32	44	201	114	141	60	SOMT 130408	174,00 €	
ATUM 39XD3 SOMT 130408	39	32	44	204	117	144	60	SOMT 130408	174,00 €	
ATUM 40XD3 SOMT 130408	40	32	44	207	120	147	60	SOMT 130408	174,00 €	
ATUM 45XD3 SOMT 150510	45	40	54	237	135	167	70	SOMT 150510	202,00 €	
ATUM 49XD3 SOMT 150510	49	40	54	249	147	179	70	SOMT 150510	248,00 €	
ATUM 50XD3 SOMT 150510	50	40	54	252	150	182	70	SOMT 150510	270,00 €	

	CODE / TYP	TOOL DIMENSIONS (mm) <small>MAB</small>							CUTTING INSERT WENDE PLATTE	PRICE / PREIS
		d	d <sub>1</sub>	d <sub>2</sub>	l	l <sub>1</sub>	l <sub>2</sub>	l <sub>3</sub>		
<p><b>D4</b></p>   <p>COMPATIBLE WITH TGTC INSERT KOMPATIBEL FÜR WENDESCHNEIDPLATTEN TGTC</p>	ATUM 14XD4 SOMT 050204	14	20	25	128	56	78	50	SOMT 050204	259,00 €
	ATUM 16XD4 SOMT 050204	16	25	34	142	64	86	56	SOMT 050204	259,00 €
	ATUM 17XD4 SOMT 060204	17	25	34	146	68	90	56	SOMT 060204	259,00 €
	ATUM 18XD4 SOMT 060204	18	25	34	150	72	94	56	SOMT 060204	259,00 €
	ATUM 19XD4 SOMT 060204	19	25	34	154	76	98	56	SOMT 060204	259,00 €
	ATUM 20XD4 SOMT 070306	20	25	34	158	80	102	56	SOMT 070306	270,00 €
	ATUM 21XD4 SOMT 070306	21	25	34	162	84	106	56	SOMT 070306	270,00 €
	ATUM 22XD4 SOMT 070306	22	25	34	166	88	110	56	SOMT 070306	270,00 €
	ATUM 24XD4 SOMT 08T306	24	25	34	174	96	118	56	SOMT 08T306	282,00 €
	ATUM 25XD4 SOMT 08T306	25	25	34	178	100	122	56	SOMT 08T306	282,00 €

**U-DRILL SYSTEM / VOLLBOHRER (SOMT)**

	CODE / TYP	TOOL DIMENSIONS (mm) <i>MAB</i>						CUTTING INSERT WENDE PLATTE	PRICE / PREIS	
		d	d <sub>1</sub>	d <sub>2</sub>	l	l <sub>1</sub>	l <sub>2</sub>			l <sub>3</sub>
<b>D5</b>    COMPATIBLE WITH TGTC INSERT KOMPATIBEL FÜR WENDESCHNEIDPLATTEN TGTC	ATUM 14XD5 SOMT 050204	14	20	25	142	70	92	50	SOMT 050204	275,00 €
	ATUM 15XD5 SOMT 050204	15	20	25	147	75	97	50	SOMT 050204	275,00 €
	ATUM 15.5XD5 SOMT 050204	15.5	20	25	147	75	97	50	SOMT 050204	275,00 €
	ATUM 16XD5 SOMT 050204	16	25	34	158	80	102	56	SOMT 050204	275,00 €
	ATUM 17.5XD5 SOMT 060204	17	25	34	163	85	107	56	SOMT 060204	275,00 €
	ATUM 18XD5 SOMT 060204	18	25	34	168	90	112	56	SOMT 060204	275,00 €
	ATUM 19XD5 SOMT 060204	19	25	34	173	95	117	56	SOMT 060204	275,00 €
	ATUM 19.5XD5 SOMT 070306	19	25	34	173	95	117	56	SOMT 070306	275,00 €
	ATUM 20XD5 SOMT 070306	20	25	34	178	100	122	56	SOMT 070306	286,00 €
	ATUM 21XD5 SOMT 070306	21	25	34	183	105	127	56	SOMT 070306	286,00 €
	ATUM 22XD5 SOMT 070306	22	25	34	188	110	132	56	SOMT 070306	286,00 €
	ATUM 23XD5 SOMT 08T306	23	25	34	193	115	137	56	SOMT 08T306	286,00 €
	ATUM 24XD5 SOMT 08T306	24	25	34	198	120	142	56	SOMT 08T306	297,00 €
	ATUM 25XD5 SOMT 08T306	25	25	34	203	125	147	56	SOMT 08T306	297,00 €
	ATUM 26XD5 SOMT 08T306	26	25	34	208	130	152	56	SOMT 08T306	297,00 €
	ATUM 27XD5 SOMT 09T308	27	25	34	213	135	157	56	SOMT 09T308	297,00 €
	ATUM 28XD5 SOMT 09T308	28	25	34	218	140	162	56	SOMT 09T308	297,00 €
	ATUM 29XD5 SOMT 09T308	29	25	34	223	145	167	56	SOMT 09T308	297,00 €
	ATUM 30XD5 SOMT 09T308	30	32	44	237	150	177	60	SOMT 09T308	306,00 €
	ATUM 33XD5 SOMT 11T308	33	32	44	252	165	192	60	SOMT 11T308	306,00 €
ATUM 34XD5 SOMT 11T308	34	32	44	257	170	197	60	SOMT 11T308	306,00 €	
ATUM 35XD5 SOMT 11T308	35	32	44	262	175	202	60	SOMT 11T308	306,00 €	
ATUM 36XD5 SOMT 11T308	36	32	44	267	180	207	60	SOMT 11T308	306,00 €	

**EXCENTRIC ADAPTOR FOR U-DRILLS / EXZENTRISCHER ADAPTER FÜR WENDEPLATTENBOHRER**

	CODE / TYP	TOOL DIMENSIONS (mm) <i>MAB</i>			PRICE / PREIS
		d	D	L	
	AET-2025	20	25	44	72,00 €
	AET-2532	25	32	46	72,00 €
	AET-3240	32	40	55	72,00 €
CAN BE ADJUSTABLE BETWEEN $\varnothing+0,4 - \varnothing-0,2$ AS DECIMAL FOR EXAMPLE: $\varnothing25$ TOOL; CAN BE ADJUSTABLE BETWEEN 24,80 $\approx$ 25,4		ZWISCHEN $-0,2$ mm UND $+0,4$ mm EINSTELLBAR BEISPIEL WERKZEUG : $\varnothing25$ = WERKZEUG ZWISCHEN 24,80 $\approx$ 25,4 EINSTELLBAR			



**DRILL CHAMFERING RING TOOLS / VOLLBOHRER RING FASENFRÄSER**

	CODE / TYP	COMPATIBLE ATUM DIAMETER	CUTTING INSERT WENDE PLATTE	PRICE / PREIS
	ADCR-120-VB1103	12.5	VBM. 1103..	79,00 €
	ADCR-125-VB1103	13	VBM. 1103..	79,00 €
	ADCR-130-VB1103	13.5	VBM. 1103..	79,00 €
	ADCR-135-VB1103	14	VBM. 1103..	79,00 €
	ADCR-140-VB1103	14.5	VBM. 1103..	79,00 €
	ADCR-145-VB1103	15	VBM. 1103..	79,00 €
	ADCR-150-VB1103	15.5-16	VBM. 1103..	79,00 €
	ADCR-155-VB1103	16.5	VBM. 1103..	79,00 €
	ADCR-160-VB1103	17	VBM. 1103..	83,00 €
	ADCR-165-VB1103	17.5	VBM. 1103..	83,00 €
	ADCR-170-VB1103	18	VBM. 1103..	83,00 €
	ADCR-175-VB1103	18.5	VBM. 1103..	83,00 €
	ADCR-180-VB1103	19	VBM. 1103..	83,00 €
	ADCR-185-VB1103	19.5	VBM. 1103..	83,00 €
	ADCR-190-VB1103	20	VBM. 1103..	83,00 €
	ADCR-195-VB1103	20.5	VBM. 1103..	83,00 €
	ADCR-200-VB1103	21	VBM. 1103..	87,00 €
	ADCR-205-VB1103	21.5	VBM. 1103..	87,00 €
	ADCR-210-VB1103	22	VBM. 1103..	87,00 €
	ADCR-215-VB1103	22.5	VBM. 1103..	87,00 €
	ADCR-220-VB1103	23	VBM. 1103..	87,00 €
	ADCR-225-VB1103	23.5	VBM. 1103..	87,00 €
	ADCR-230-VB1103	24	VBM. 1103..	87,00 €
	ADCR-235-VB1103	24.5	VBM. 1103..	87,00 €
	ADCR-240-VB1103	25	VBM. 1103..	87,00 €
	ADCR-245-VB1103	25.5	VBM. 1103..	87,00 €
	ADCR-250-VB1103	26	VBM. 1103..	94,00 €
	ADCR-255-VB1103	26.5	VBM. 1103..	94,00 €
	ADCR-260-VB1103	27	VBM. 1103..	94,00 €
	ADCR-265-VB1103	27.5	VBM. 1103..	94,00 €
	ADCR-270-VB1103	28	VBM. 1103..	94,00 €
	ADCR-275-VB1103	28.5	VBM. 1103..	94,00 €
	ADCR-280-VB1103	29	VBM. 1103..	94,00 €
	ADCR-285-VB1103	29.5	VBM. 1103..	94,00 €
	ADCR-290-VB1103	30	VBM. 1103..	94,00 €
ADCR-295-VB1103	30.5	VBM. 1103..	94,00 €	
ADCR-300-VB1103	31	VBM. 1103..	94,00 €	

**DRILLING, BORING and EXTERNAL TURNING / MULTIFUNKTIONALES DREH-UND BOHRWERKZEUG**

	CODE / TYP	TOOL DIMENSIONS (mm) MAB							CUTTING INSERT WENDE PLATTE	PRICE / PREIS
		ød	ød1	ød2	l1	l2	l3	f		
 <p>COMPATIBLE WITH CRTZT-ISCR-TGTC-KRLY INSERT KOMPATIBEL FÜR WENDESCHNEIDPLATTEN CRTZT-ISCR-TGTC-KRLY</p>	AEKL/R-D2.25X8 XC.. 040104	8	10	12	18	22	38	4	XC.. 040104	112,00 €
	AEKL/R-D2.25X10 XC.. 050204	10	12	16	22.5	27.5	42	5	XC.. 050204	112,00 €
	AEKL/R-D2.25X12 XC.. 060204	12	16	20	27	33	45	6	XC.. 060204	118,00 €
	AEKL/R-D2.25X14 XC.. 070304	14	16	20	31.5	38	45	7	XC.. 070304	123,00 €
	AEKL/R-D2.25X16 XC.. 080304	16	20	25	36	44	50	8	XC.. 080304	128,00 €
	AEKL/R-D2.25X18 XC.. 09T304	18	25	32	40.5	50	56	9	XC.. 09T304	144,00 €
	AEKL/R-D2.25X20 XC.. 10T304	20	25	32	45	55	56	10	XC.. 10T304	158,00 €
	AEKL/R-D2.25X25 XC.. 130404	25	32	40	56.5	69	60	12.5	XC.. 130404	179,00 €
	AEKL/R-D2.25X32 XC.. 170504	32	40	50	72	88	70	16	XC.. 170504	185,00 €

## ROUGH BORING HEADS / SCHRUPP-SPINDELKOPF

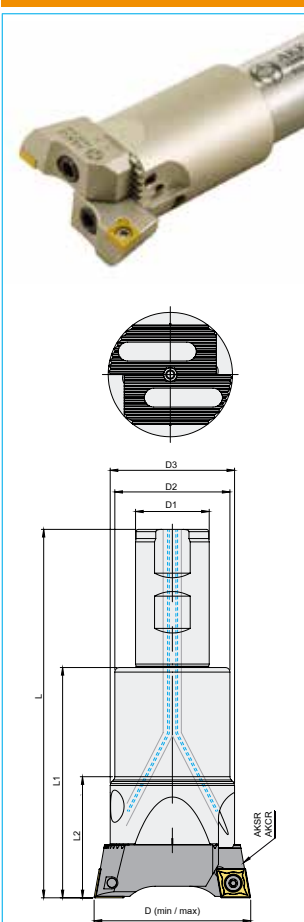
	CODE / TYP	TOOL DIMENSIONS (mm) MAß						CARTRIDGE KURZDREHHALTER	PRICE / PREIS	
		D <sub>min</sub> / D <sub>max</sub>	D <sub>1</sub>	D <sub>2</sub>	D <sub>3</sub>	L	L <sub>1</sub>			L <sub>2</sub>
	ABHR-D18x22-W16-L90-CC06	18-22	16	-	-	90	42	-	AK.. 18-22	265,00 €
	ABHR-D18x22-W16-L150-CC06	18-22	16	-	-	150	102	-	AK.. 18-22	316,00 €
	ABHR-D18x22-W16-L200-CC06	18-22	16	-	-	200	152	-	AK.. 18-22	398,00 €
	ABHR-D22x28-W20-L100-CC06	22-28	20	-	-	100	50	-	AK.. 22-28	275,00 €
	ABHR-D22x28-W20-L150-CC06	22-28	20	-	-	150	100	-	AK.. 22-28	332,00 €
	ABHR-D22x28-W20-L200-CC06	22-28	20	-	-	200	150	-	AK.. 22-28	413,00 €
	ABHR-D28x38-W20-L110-CC06	28-38	20	25	-	110	60	-	AK.. 28-38	281,00 €
	ABHR-D28x38-W20-L160-CC06	28-38	20	25	-	160	110	-	AK.. 28-38	337,00 €
	ABHR-D28x38-W20-L230-CC06	28-38	20	25	-	230	180	-	AK.. 28-38	423,00 €
	ABHR-D36x50-W25-L120-CC06	36-50	25	32	-	120	64	-	AK.. 36-50	286,00 €
	ABHR-D36x50-W25-L170-CC06	36-50	25	32	-	170	114	-	AK.. 36-50	342,00 €
	ABHR-D36x50-W25-L250-CC06	36-50	25	32	-	250	194	-	AK.. 36-50	428,00 €
	ABHR-D36x50-W25-L120-CC09	36-50	25	32	-	120	64	-	AK.. 36-50-09	286,00 €
	ABHR-D36x50-W25-L170-CC09	36-50	25	32	-	170	114	-	AK.. 36-50-09	342,00 €
	ABHR-D36x50-W25-L250-CC09	36-50	25	32	-	250	194	-	AK.. 36-50-09	428,00 €
	ABHR-D50x68-W32-L140-CC09	50-68	32	40	-	140	80	-	AK.. 50-68	296,00 €
	ABHR-D50x68-W32-L200-CC09	50-68	32	40	-	200	140	-	AK.. 50-68	357,00 €
	ABHR-D50x68-W32-L280-CC09	50-68	32	40	-	280	220	-	AK.. 50-68	444,00 €
	ABHR-D50x68-W32-L140-CC12	50-68	32	40	-	140	80	-	AK.. 50-68-12	296,00 €
	ABHR-D50x68-W32-L200-CC12	50-68	32	40	-	200	140	-	AK.. 50-68-12	357,00 €
	ABHR-D50x68-W32-L280-CC12	50-68	32	40	-	280	220	-	AK.. 50-68-12	444,00 €
	ABHR-D68x90-W32-L160-CC12	68-90	32	50	54	160	100	50	AK.. 68-90	326,00 €
	ABHR-D68x90-W32-L210-CC12	68-90	32	50	54	210	150	50	AK.. 68-90	393,00 €
	ABHR-D68x90-W32-L280-CC12	68-90	32	50	54	280	220	50	AK.. 68-90	490,00 €
	ABHR-D90x120-W32-L140-CC12	90-120	32	63	72	140	80	63	AK.. 90-120	357,00 €
	ABHR-D90x120-W40-L200-CC12	90-120	40	63	72	200	130	63	AK.. 90-120	388,00 €
	ABHR-D90x120-W40-L300-CC12	90-120	40	63	72	300	230	63	AK.. 90-120	464,00 €
	ABHR-D120x160-W40-L210-CC12	120-160	40	80	95	210	140	75	AK.. 120-160	612,00 €
	ABHR-D120x160-W40-L300-CC12	120-160	40	80	95	300	230	75	AK.. 120-160	734,00 €
	ABHR-D160x200-W40-L210-B-CC12	160-200	40	80	95	210	140	75	AK.. 160-800	816,00 €
ABHR-D160x200-W40-L300-B-CC12	160-200	40	80	95	300	230	75	AK.. 160-800	979,00 €	

## ADJUSTABLE ROUGH BORING HEADS BODY / TRÄGERWERKZEUG FÜR EINSTELLBARE SCHRUPP-BOHRKÖPFE

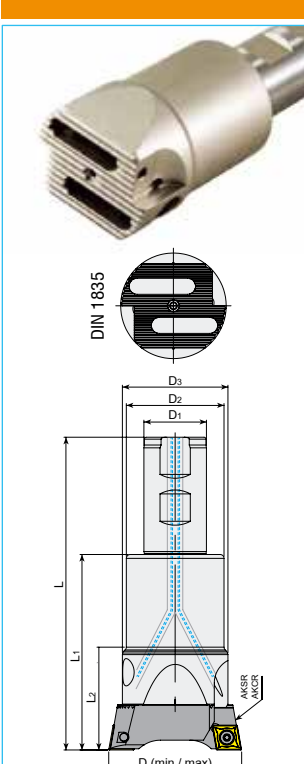
	CODE / TYP	TOOL DIMENSIONS (mm) MAß						CARTRIDGE KURZDREHHALTER	PRICE / PREIS	
		D <sub>min</sub> / D <sub>max</sub>	D <sub>1</sub>	D <sub>2</sub>	D <sub>3</sub>	L	L <sub>1</sub>			L <sub>2</sub>
	ABHRS-D16x42-W16-L90	18-22	16	-	-	90	42	-	AK.. 18-22	123,00 €
	ABHRS-D16x102-W16-L150	18-22	16	-	-	150	102	-	AK.. 18-22	174,00 €
	ABHRS-D16x152-W16-L200	18-22	16	-	-	200	152	-	AK.. 18-22	256,00 €
	ABHRS-D20x50-W20-L100	22-28	20	-	-	100	50	-	AK.. 22-28	121,00 €
	ABHRS-D20x100-W20-L150	22-28	20	-	-	150	100	-	AK.. 22-28	178,00 €
	ABHRS-D20x150-W20-L200	22-28	20	-	-	200	150	-	AK.. 28-38	259,00 €
	ABHRS-D25x60-W20-L110	28-38	20	25	-	110	60	-	AK.. 28-38	117,00 €
	ABHRS-D25x110-W20-L160	28-38	20	25	-	160	110	-	AK.. 28-38	173,00 €
	ABHRS-D25x180-W20-L230	28-38	20	25	-	230	180	-	AK.. 28-38	259,00 €
	ABHRS-D32x64-W25-L120	36-50	25	32	-	120	64	-	AK.. 36-50	112,00 €
	ABHRS-D32x114-W25-L170	36-50	25	32	-	170	114	-	AK.. 36-50	168,00 €
	ABHRS-D32x194-W25-L250	36-50	25	32	-	250	194	-	AK.. 36-50	254,00 €
	ABHRS-D40x80-W32-L140	50-68	32	40	-	140	80	-	AK.. 50-68	112,00 €
	ABHRS-D40x140-W32-L200	50-68	32	40	-	200	140	-	AK.. 50-68	173,00 €
	ABHRS-D40x220-W32-L280	50-68	32	40	-	280	220	-	AK.. 50-68	260,00 €
	ABHRS-D50x100-W32-L160	68-90	32	50	54	160	100	50	AK.. 68-90	132,00 €
	ABHRS-D50x150-W32-L210	68-90	32	50	54	210	150	50	AK.. 68-90	199,00 €
	ABHRS-D50x220-W32-L280	68-90	32	50	54	280	220	50	AK.. 68-90	296,00 €
	ABHRS-D63x80-W32-L140	90-120	32	63	72	140	80	63	AK.. 90-120	153,00 €
	ABHRS-D63x130-W40-L200	90-120	40	63	72	200	130	63	AK.. 90-120	184,00 €
	ABHRS-D63x230-W40-L300	90-120	40	63	72	300	230	63	AK.. 90-120	260,00 €
	ABHRS-D80x140-W40-L210	120-160	40	80	95	210	140	75	AK.. 120-160	398,00 €
	ABHRS-D80x230-W40-L300	120-160	40	80	95	300	230	75	AK.. 120-160	520,00 €
	ABHRS-D80x140-W40-L210	160-200	40	80	95	210	140	75	AK.. 160-800	592,00 €
	ABHRS-D80x230-W40-L300	160-200	40	80	95	300	230	75	AK.. 160-800	755,00 €

ROUGH BORING HEADS CARTRIDGE / SCHRUPP-SPINDELKOPF KURZDREHHALTER

62/63

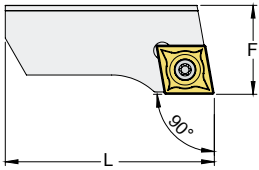
	CODE / TYP	TOOL DIMENSIONS (mm) <small>MAß</small>			CUTTING INSERT WENDE PLATTE	PRICE / PREIS
		Dmin / Dmax	F	L		
 	AKSR 18-22	18-22	9	15	CC.. 0602..	71,00 €
	AKSR 22-28	22-28	10	19	ISO	77,00 €
	AKSR 28-38	28-38	13	23		82,00 €
	AKSR 36-50	36-50	16	32		87,00 €
	AKSR 36-50-09	36-50	16	32	CC.. 09T3..	87,00 €
	AKSR 50-68	50-68	20	40	ISO	92,00 €
	AKSR 50-68-12	50-68	20	40	CC.. 1204..	92,00 €
	AKSR 68-90	68-90	23	54	ISO	97,00 €
	AKSR 90-120	90-120	28	70		102,00 €
	AKSR 120-160	120-160	33	95		107,00 €
AKSR 160-800	160-800	33	130		112,00 €	

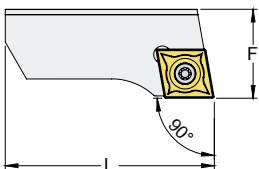
	CODE / TYP	TOOL DIMENSIONS (mm) <small>MAß</small>			CUTTING INSERT WENDE PLATTE	PRICE / PREIS
		Dmin / Dmax	F	L		
 	AKCR 28-38	28-38	12.8	23	CC.. 0602..	82,00 €
	AKCR 36-50	36-50	15.8	32	ISO	87,00 €
	AKCR 36-50-09	36-50	15.8	32	CC.. 09T3..	87,00 €
	AKCR 50-68	50-68	19.7	40	ISO	92,00 €
	AKCR 50-68-12	50-68	19.7	40	CC.. 1204..	92,00 €
	AKCR 68-90	68-90	22.7	54	ISO	97,00 €
	AKCR 90-120	90-120	27.7	70		102,00 €
	AKCR 120-160	120-160	32.7	95		107,00 €
	AKCR 160-800	160-800	32.7	130		112,00 €



HELIX CHAMFER MILLING TOOLS / HELIX-FASFRÄSE

	CODE / TYP	Z		TOOL DIMENSIONS (mm) <small>MAß</small>						PRICE / PREIS
		Total	Effective	α	da	D	d	a	L	
	AHM15-AP16-D35x93-A27-Z0306-H	6	3	15	35	93	27	8	50	350,00 €
	AHM30-AP16-D35x87-A27-Z0306-H	6	3	30	35	87	27	15	50	350,00 €
	AHM45-AP16-D35x77-A27-Z0306-H	6	3	45	35	77	27	21.5	50	350,00 €
	AHM60-AP16-D35x65-A22-Z0306-H	6	3	60	35	65	22	26.5	50	350,00 €
	AHM75-AP16-D35x50-A22-Z0306-H	6	3	75	35	50	22	29.5	50	350,00 €

COUNTERSINK MILLING TOOL FOR CYLINDRICAL ALLEN HEAD SCREWS (DIN 974-1)  
SENKWERKZEUG FÜR ZYLINDERKOPFSCHRAUBEN (DIN 974-1)

	CODE / TYP	TOOL DIMENSIONS (mm) <small>MAß</small>						PRICE / PREIS
		da	D	d	I	L	For Screws	
	ACBM-CC06-D17X6-W16-L150-Z02	6	17	16	30	150	M10	102,00 €
	ACBM-CC06-D18X7-W16-L100-Z02-H	7	18	16	32	100	M10	82,00 €
	ACBM-CC06-D18X7-W16-L160-Z02-H	7	18	16	32	160	M10	109,00 €
	ACBM-CC06-D20X9-W20-L100-Z02-H	9	20	20	40	100	M12	87,00 €
	ACBM-CC06-D20X9-W20-L160-Z02-H	9	20	20	38	160	M12	116,00 €
	ACBM-CC09-D26X8.5-W25-L130-Z02-H	8.5	26	25	50	130	M16	92,00 €
	ACBM-CC09-D26X8.5-W25-L200-Z02	8.5	26	25	50	200	M16	123,00 €
	ACBM-CC09-D33X15.5-W32-L130-Z02-H	15.5	33	32	65	130	M20	102,00 €
	ACBM-CC09-D33X15.5-W32-L200-Z02	15.5	33	32	65	200	M20	139,00 €
	ACBM-SP06-D15X4-W16-L160-Z02-H	4	15	16	80	160	M8	109,00 €

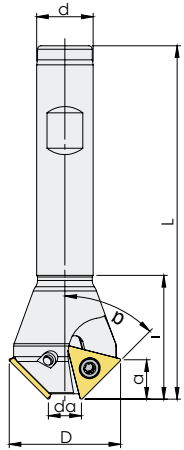
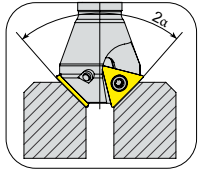
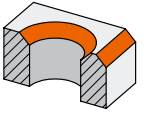
**CHAMFERING TOOLS / FASENFRÄSER**

	CODE / TYP	TOOL DIMENSIONS (mm) MAß							CUTTING INSERT WENDE PLATTE	PRICE / PREIS
		$\alpha$	$d_a$	D	d	L	l	a		
   	ACM10-TC16-D17X22-W16-L90-Z01	10°	17	22	16	90	30	15.2		56,00 €
	ACM15-TC16-D17X24-W16-L90-Z01	15°	17	24	16	90	30	14.9		56,00 €
	ACM15-TC16-D22X29-W16-L100-Z01	15°	22	29	16	100	30	14.9		56,00 €
	ACM15-TC16-D30X37-W20-L100-Z02	15°	30	37	20	100	35	14.9		82,00 €
	ACM15-TC16-D35X42-W20-L100-Z03	15°	35	42	20	100	38	14.9		92,00 €
	ACM15-TC16-D52X59-W25-L110-Z03	15°	52	59	25	110	40	14.9		92,00 €
	ACM17.5-TC16-D17X25-W16-L90-Z01	17.5°	17	25	16	90	30	14.7		56,00 €
	ACM18.5-TC16-D21.3X30-W20-L100-Z02	18.5°	21.3	30	20	100	30	13.5		56,00 €
	ACM20-TC16-D12X22-W16-L100-Z01	20°	12	22	16	100	30	14.4		56,00 €
	ACM20-TC16-D17X27-W16-L100-Z01	20°	17	27	16	100	30	14.4		56,00 €
	ACM20-TC16-D23X33-W20-L100-Z02	20°	23	33	20	100	30	14.4		82,00 €
	ACM20-TC16-D28X38-W20-L100-Z02	20°	28	38	20	100	35	14.4	T.C.T 16T304	82,00 €
	ACM20-TC16-D35X45-W20-L100-Z03	20°	35	45	20	100	40	14.4	ISO	92,00 €
	ACM20-TC16-D39X49-W20-L100-Z03	20°	39	49	20	100	40	14.4		92,00 €
	ACM20-TC16-D45X55-W25-L110-Z03	20°	45	55	25	110	40	14.4		92,00 €
	ACM20-TC16-D51X61-W25-L110-Z03	20°	51	61	25	110	40	14.4		92,00 €
	ACM22.5-TC16-D17X28-W16-L100-Z01	22.5°	17	28	16	100	30	14.2		56,00 €
	ACM25-TC16-D17X29-W16-L100-Z01	25°	17	29	16	100	30	13.9		56,00 €
	ACM30-TC16-D6X20-W16-L100-Z01	30°	6	20	16	100	30	13.3		56,00 €
	ACM30-TC16-D15X30-W16-L100-Z01	30°	15	30	16	100	30	13.3		56,00 €
	ACM30-TC16-D17.5X32.5-W20-L100-Z02	30°	17.5	32.5	20	100	30	13.3		56,00 €
	ACM30-TC16-D20X35-W16-L100-Z02	30°	20	35	16	100	35	13.3		56,00 €
	ACM30-TC16-D30X45-W20-L100-Z02	30°	30	45	20	100	40	13.3		56,00 €
	ACM30-TC16-D35X50-W20-L100-Z03	30°	35	50	20	100	40	13.3		92,00 €
	ACM30-TC16-D45X60-W25-L110-Z03	30°	45	60	25	110	40	13.3		92,00 €
	ACM45-TC09-D7X18-W16-L100-Z02	45°	7	18	16	100	25	5.9	T.C.T 090204	56,00 €
	ACM45-TC11-D11X24-W16-L100-Z02	45°	11	24	16	100	25	6.9	T.C.T 110204	56,00 €
	ACM45-TC16-D5X26-W16-L100-Z01	45°	5	26	16	100	30	10.8		56,00 €
	ACM45-TC16-D10X31-W16-L100-Z02	45°	10	31	16	100	35	10.8		56,00 €
	ACM45-TC16-D10X31-W20-L100-Z02	45°	10	31	20	100	35	10.8		56,00 €
ACM45-TC16-D18X39-W16-L100-Z02	45°	18	39	16	100	40	10.8		56,00 €	
ACM45-TC16-D18X39-W20-L100-Z02	45°	18	39	20	100	40	10.8	T.C.T 16T304	56,00 €	
ACM45-TC16-D20X41-W20-L100-Z02	45°	20	41	20	100	40	10.8	ISO	56,00 €	
ACM45-TC16-D30X51-W20-L100-Z02	45°	30	51	20	100	40	10.8		56,00 €	
ACM55-TC16-D16X40-W20-L100-Z03	55°	16	40	20	100	40	8.7		92,00 €	
ACM62-TC16-D14X40-W20-L100-Z03	62°	14	40	20	100	40	7.1		92,00 €	
ACM72-TC16-D14X42-W20-L100-Z03	72°	14	42	20	100	40	4.6		92,00 €	
	ACM45-SP1104-D12x26-W20-L150-Z01	45°	12	26	20	150	30	-	SPGT 110408	69,00 €
	ACM45-SP1104-D25x39-W25-L150-Z02	45°	25	39	25	150	35	-	FOR ZCC	87,00 €
	ACM45-SP1104-D32x46-W32-L150-Z03	45°	32	46	32	150	40	-	INSERT.	104,00 €

**END MILLS / WP - SCHAFTFRÄSER**

	CODE / TYP	TOOL DIMENSIONS (mm) MAß						CUTTING INSERT WENDE PLATTE	PRICE / PREIS
		D	Z	d	L	l	a		
 <b>90°</b>	AEM90-AD1505-D25-W25-L150-Z02	25	2	25	150	50	15	AD.. 1505..	106,00 €
	AEM90-AD1505-D30-W25-L150-Z03	30	3	25	150	50	15	FOR ISCR	121,00 €
	AEM90-AD1505-D32-W32-L150-Z03	32	3	32	150	50	15	INSERT.	121,00 €



END MILLS / WP - SCHAFTFRÄSER

	CODE / TYP	TOOL DIMENSIONS (mm) Maß						CUTTING INSERT WENDE PLATTE	PRICE / PREIS
		D	Z	d	L	l	a		
	AEM90-AD0803-D16-W16-L150-Z02	16	2	16	150	30	8		87,00 €
	AEM90-AD0803-D17-W16-L150-Z02	17	2	16	150	30	8	ADMT 0803..	87,00 €
	AEM90-AD0803-D17-W16-L200-Z02	17	2	16	200	30	8	FOR WLTR	123,00 €
	AEM90-AD0803-D20-W20-L150-Z03	20	3	20	150	30	8	INSERT.	104,00 €
	AEM90-AD0803-D21-W20-L200-Z03	21	3	20	200	30	8		165,00 €
	AEM90-AD10T3-D16-W16-L100-Z02-H	16	2	16	100	30	10		87,00 €
	AEM90-AD10T3-D16-W16-L150-Z02	16	2	16	150	40	10		87,00 €
	AEM90-AD10T3-D16-C16-L200-Z02	16	2	16	200	50	10		123,00 €
	AEM90-AD10T3-D17-W16-L150-Z02	17	2	16	150	30	10		87,00 €
	AEM90-AD10T3-D17-W16-L200-Z02	17	2	16	200	30	10		123,00 €
	AEM90-AD10T3-D20-W20-L70-Z03	20	3	20	70	30	10	ADMT 10T3..	94,00 €
	AEM90-AD10T3-D20-W20-L100-Z03-H	20	3	20	100	30	10	FOR WLTR	104,00 €
	AEM90-AD10T3-D20-W20-L150-Z03	20	3	20	150	30	10	INSERT.	104,00 €
	AEM90-AD10T3-D20-C20-L150-Z03	20	3	20	150	40	10		104,00 €
	AEM90-AD10T3-D20-C20-L200-Z03	20	3	20	200	40	10		170,00 €
	AEM90-AD10T3-D25-W25-L100-Z03-H	25	3	25	100	30	10		108,00 €
	AEM90-AD10T3-D25-W25-L100-Z04-H	25	4	25	100	30	10		129,00 €
	AEM90-AD10T3-D25-W25-L150-Z03	25	3	25	150	50	10		108,00 €
	AEM90-AD1204-D20-W20-L150-Z02	20	2	20	150	50	12	ADMT 1204..	94,00 €
	AEM90-AD1204-D25-W25-L150-Z03	25	3	25	150	50	12	FOR WLTR	110,00 €
AEM90-AD1204-D26-W25-L180-Z03	26	3	25	180	35	12	INSERT.	154,00 €	
AEM90-AD1204-D32-W32-L150-Z04	32	4	32	150	50	12		125,00 €	
AEM90-AD1606-D25-W25-L150-Z02	25	2	25	150	50	15	ADMT 1606..	110,00 €	
AEM90-AD1606-D32-W32-L150-Z03	32	3	32	150	50	15	FOR WLTR INSERT.	125,00 €	
	AEM90-AD1003-D16-C16-L150-Z02	16	2	16	150	30	8		87,00 €
	AEM90-AD1003-D17-C16-L150-Z02	17	2	16	150	25	8		87,00 €
	AEM90-AD1003-D20-C20-L200-Z03	20	3	20	200	50	8	ADMT 1003..	158,00 €
	AEM90-AD1003-D21-C20-L200-Z03	21	3	20	200	25	8	FOR DJT	158,00 €
	AEM90-AD1003-D25-C25-L200-Z03	25	3	25	200	50	8	INSERT.	168,00 €
	AEM90-AD1003-D26-C25-L150-Z03	26	3	25	150	30	8		97,00 €
	AEM90-AD1003-D26-C25-L200-Z03	26	3	25	200	30	8		155,00 €
	AEM90-AD1505D-D25-W25-L150-Z02	25	2	25	150	50	14.3	ADKT 150508	106,00 €
	AEM90-AD1505D-D32-W32-L150-Z03	32	3	32	150	50	14.3	FOR DJT INSERT.	121,00 €
	AEM90-AN11-D22-W20-L150-Z02	22	2	20	150	30	11		114,00 €
	AEM90-AN11-D25-W25-L150-Z02	25	2	25	150	40	11		100,00 €
	AEM90-AN11-D25-C25-L200-Z02	25	2	25	200	40	11		150,00 €
	AEM90-AN11-D26-W25-L150-Z02	26	2	25	150	40	11	ANGX 110508	120,00 €
	AEM90-AN11-D28-W25-L150-Z02	28	2	25	150	25	11	FOR ZCC	120,00 €
	AEM90-AN11-D32-W32-L150-Z03	32	3	32	150	50	11	INSERT.	116,00 €
	AEM90-AN11-D32-C32-L200-Z03	32	3	32	200	50	11		174,00 €
	AEM90-AN11-D40-W32-L150-Z04	40	4	32	150	40	11		133,00 €
	AEM90-AN1607-D32-C25-L150-Z02	32	2	25	150	40	15	AN.X 1607..	123,00 €
	AEM90-AN1607-D40-C32-L150-Z03	40	3	32	150	45	15	FOR TGTC INSERT.	155,00 €

**END MILLS / WP - SCHAFTFRÄSER**

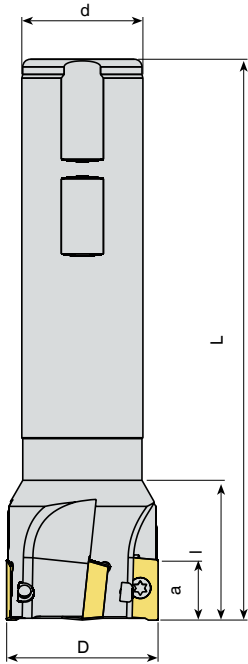
	CODE / TYP	TOOL DIMENSIONS (mm) <i>MAß</i>						CUTTING INSERT WENDE PLATTE	PRICE / PREIS
		D	Z	d	L	l	a		
    <b>90°</b>	AEM90-AP06-D10-C10-L120-Z02	10	2	10	120	20	5.6	APMT 0602..	119,00 €
	AEM90-AP06-D12-C12-L120-Z02	12	2	12	120	20	5.6	FOR KRLY INSERT.	119,00 €
	AEM90-AP0903-D16-C16-L150-Z02	16	2	16	150	30	9	APMT 0903..	97,00 €
	AEM90-AP0903-D17-C16-L150-Z02	17	2	16	150	30	9		97,00 €
	AEM90-AP0903-D20-C20-L150-Z02	20	2	20	150	30	9	FOR KRLY	107,00 €
	AEM90-AP0903-D21-C20-L150-Z02	21	2	20	150	30	9	INSERT.	107,00 €
	AEM90-AP0903-D25-C25-L150-Z03	25	3	25	150	30	9		117,00 €
	<small>NEW</small> AEM90-AP09-D16-C16-L100-Z02-H	16	2	16	100	30	8.8		79,00 €
	AEM90-AP09-D16-C15-L150-Z02	16	2	15	150	25	8.8		97,00 €
	<small>NEW</small> AEM90-AP09-D16-W16-L150-Z02-H	16	2	16	150	25	8.8		89,00 €
	<small>NEW</small> AEM90-AP09-D16-C16-L200-Z02-H	16	2	16	200	100	8.8		159,00 €
	AEM90-AP09-D17-C16-L150-Z02	17	2	16	150	25	8.8	APKT 09T3..	97,00 €
	<small>NEW</small> AEM90-AP09-D20-C20-L150-Z03-H	20	3	20	150	50	8.8	FOR TGTC	102,00 €
	<small>NEW</small> AEM90-AP09-D20-C20-L200-Z03-H	20	3	20	200	100	8.8	INSERT.	171,00 €
	<small>NEW</small> AEM90-AP09-D20-C20-L250-Z02-H	20	2	20	250	150	8.8		255,00 €
	AEM90-AP09-D21-C20-L150-Z03	21	3	20	150	25	8.8		113,00 €
	AEM90-AP09-D26-C25-L150-Z04	26	4	25	150	30	8.8		129,00 €
	AEM90-AP10-D12-W16-L100-Z01-H	12	1	16	100	30	10		67,00 €
	AEM90-AP10-D12-W16-L150-Z01	12	1	16	150	38	10		67,00 €
	AEM90-AP10-D14-W16-L100-Z01-H	14	1	16	100	30	10		67,00 €
	AEM90-AP10-D14-W16-L150-Z01	14	1	16	150	38	10		67,00 €
	AEM90-AP10-D16-C16-L100-Z02-H	16	2	16	100	30	10		79,00 €
	AEM90-AP10-D16-W16-L100-Z02-H	16	2	16	100	30	10		79,00 €
	AEM90-AP10-D16-C16-L120-Z02-H	16	2	16	120	30	10		79,00 €
	AEM90-AP10-D16-C16-L150-Z02	16	2	16	150	50	10		79,00 €
	AEM90-AP10-D16-C16-L150-Z02-H	16	2	16	150	50	10		89,00 €
	AEM90-AP10-D16-W16-L150-Z02	16	2	16	150	50	10		79,00 €
	AEM90-AP10-D16-C16-L200-Z02	16	2	16	200	100	10		112,00 €
	AEM90-AP10-D16-C16-L200-Z02-H	16	2	16	200	100	10	AP. 1003..	140,00 €
	<small>NEW</small> AEM90-AP10-D16-C16-L250-Z02	16	2	16	250	50	10	ISO	189,00 €
	AEM90-AP10-D18-W16-L100-Z02-H	18	2	16	100	30	10		81,00 €
	AEM90-AP10-D18-W16-L150-Z02	18	2	16	150	30	10		81,00 €
	AEM90-AP10-D20-C20-L100-Z03-H	20	3	20	100	30	10		91,00 €
	AEM90-AP10-D20-W20-L100-Z03-H	20	3	20	100	30	10		91,00 €
	AEM90-AP10-D20-C20-L120-Z03-H	20	3	20	120	30	10		91,00 €
	AEM90-AP10-D20-C20-L150-Z03	20	3	20	150	50	10		91,00 €
	AEM90-AP10-D20-C20-L150-Z03-H	20	3	20	150	50	10		102,00 €
	AEM90-AP10-D20-W20-L150-Z03	20	3	20	150	50	10		91,00 €
	AEM90-AP10-D20-C20-L200-Z02	20	2	20	200	100	10		140,00 €
	AEM90-AP10-D20-C20-L200-Z03-H	20	3	20	200	100	10		171,00 €
AEM90-AP10-D20-C20-L250-Z02	20	2	20	250	150	10		200,00 €	
AEM90-AP10-D20-C20-L250-Z02-H	20	2	20	250	150	10		255,00 €	
AEM90-AP10-D21-W20-L150-Z03	21	3	20	150	30	10		91,00 €	
AEM90-AP10-D22-W20-L100-Z03-H	22	3	20	100	30	10		91,00 €	
AEM90-AP10-D22-W20-L150-Z03	22	3	20	150	30	10		91,00 €	
AEM90-AP10-D23-W20-L150-Z03	23	3	20	150	30	10		91,00 €	
AEM90-AP10-D24-W20-L150-Z03	24	3	20	150	30	10		91,00 €	
AEM90-AP10-D25-W25-L100-Z04-H	25	4	25	100	30	10		117,00 €	
AEM90-AP10-D25-C25-L100-Z03-H	25	3	25	100	30	10		97,00 €	

END MILLS / WP - SCHAFTFRÄSER

	CODE / TYP	TOOL DIMENSIONS (mm) <small>MAS</small>						CUTTING INSERT WENDE PLATTE	PRICE / PREIS
		D	Z	d	L	l	a		
	AEM90-AP10-D25-W25-L100-Z03-H	25	3	25	100	30	10		97,00 €
	AEM90-AP10-D25-C25-L120-Z03-H	25	3	25	120	30	10		97,00 €
	AEM90-AP10-D25-C25-L150-Z03	25	3	25	150	50	10		97,00 €
	AEM90-AP10-D25-W25-L150-Z03	25	3	25	150	50	10		97,00 €
	AEM90-AP10-D25-C25-L200-Z02	25	2	25	200	100	10		145,00 €
	AEM90-AP10-D25-C25-L200-Z03	25	3	25	200	100	10		155,00 €
	AEM90-AP10-D25-C25-L250-Z02	25	2	25	250	100	10		183,00 €
	AEM90-AP10-D30-C25-L100-Z04-H	30	4	25	100	30	10	AP.. 1003..	107,00 €
	AEM90-AP10-D30-C25-L120-Z04-H	30	4	25	120	30	10	ISO	107,00 €
	AEM90-AP10-D30-C25-L150-Z04	30	4	25	150	30	10		107,00 €
	AEM90-AP10-D32-C25-L100-Z04-H	32	4	25	100	35	10		107,00 €
	AEM90-AP10-D32-C25-L120-Z04-H	32	4	25	120	35	10		107,00 €
	AEM90-AP10-D32-C25-L150-Z04	32	4	25	150	35	10		107,00 €
	AEM90-AP10-D32-W25-L150-Z04	32	4	25	150	35	10		107,00 €
	AEM90-AP10-D32-W32-L150-Z04	32	4	32	150	50	10		107,00 €
	AEM90-AP10-D40-W32-L150-Z05	40	5	32	150	40	10		123,00 €
	AEM90-AP10D-D16-W16-L150-Z02	16	2	16	150	50	10	AP.. 1003..	79,00 €
	AEM90-AP10D-D20-W20-L150-Z03	20	3	20	150	50	10	FOR DJT INSERT.	91,00 €
	AEM90-AP11-D16-C16-L150-Z02	16	2	16	150	50	11		79,00 €
	AEM90-AP11-D16-C16-L150-Z02-H	16	2	16	150	50	11		89,00 €
	AEM90-AP11-D16-W16-L150-Z02	16	2	16	150	50	11		79,00 €
	AEM90-AP11-D16-C16-L200-Z02	16	2	16	200	100	11		112,00 €
	AEM90-AP11-D17-C16-L150-Z02	17	2	16	150	30	11		89,00 €
	AEM90-AP11-D17-C16-L200-Z02	17	2	16	200	30	11		123,00 €
	AEM90-AP11-D20-C20-L150-Z03	20	3	20	150	50	11		91,00 €
	AEM90-AP11-D20-W20-L150-Z03	20	3	20	150	50	11		91,00 €
	AEM90-AP11-D20-W20-L150-Z03-H	20	3	20	150	50	11		102,00 €
	AEM90-AP11-D20-C20-L200-Z03	20	3	20	200	100	11	AP.. 11T3..	150,00 €
	AEM90-AP11-D21-C20-L150-Z03	21	3	20	150	30	11	FOR ZCC	91,00 €
	AEM90-AP11-D21-W20-L150-Z03	21	3	20	150	30	11	INSERT.	91,00 €
	AEM90-AP11-D21-W20-L150-Z03-H	21	3	20	150	30	11		102,00 €
	AEM90-AP11-D21-C20-L200-Z03	21	3	20	200	30	11		161,00 €
	AEM90-AP11-D25-C25-L150-Z03	25	3	25	150	50	11		97,00 €
	AEM90-AP11-D25-W25-L150-Z03	25	3	25	150	50	11		97,00 €
	AEM90-AP11-D25-W25-L150-Z03-H	25	3	25	150	50	11		107,00 €
	AEM90-AP11-D26-C25-L150-Z03	26	3	25	150	35	11		107,00 €
	AEM90-AP11-D26-C24-L150-Z03	26	3	24	150	47	11		107,00 €
	AEM90-AP11-D32-W25-L150-Z04	32	4	25	150	35	11		107,00 €
	AEM90-AP11-D32-W32-L150-Z03-H	32	3	32	150	50	11		107,00 €
	AEM90-AP11-D32-W32-L150-Z04	32	4	32	150	50	11		107,00 €
AEM90-AP1135-D16-W16-L150-Z02	16	2	16	150	50	9.5	AP.. 1135..	97,00 €	
AEM90-AP1135-D20-W20-L150-Z03	20	3	20	150	50	9.5	FOR GSC INSERT.	111,00 €	
AEM90-AP1204-D20-C20-L150-Z02	20	2	20	150	30	12		118,00 €	
AEM90-AP1204-D21-C20-L150-Z02	21	2	20	150	30	12	AP.. 1204..	118,00 €	
AEM90-AP1204-D21-C20-L200-Z02	21	2	20	200	30	12	FOR TGTC	171,00 €	
AEM90-AP1204-D25-C25-L150-Z03	25	3	25	150	40	12	INSERT.	129,00 €	
AEM90-AP1204-D26-C25-L250-Z02	26	2	25	250	35	12		236,00 €	
AEM90-AP1204-D32-C25-L150-Z03	32	3	25	150	35	12		134,00 €	
AEM90-AP16-D25-C20-L100-Z02	25	2	20	100	35	16	AP.. 1604..ISO	91,00 €	

**END MILLS / WP - SCHAFTFRÄSER**

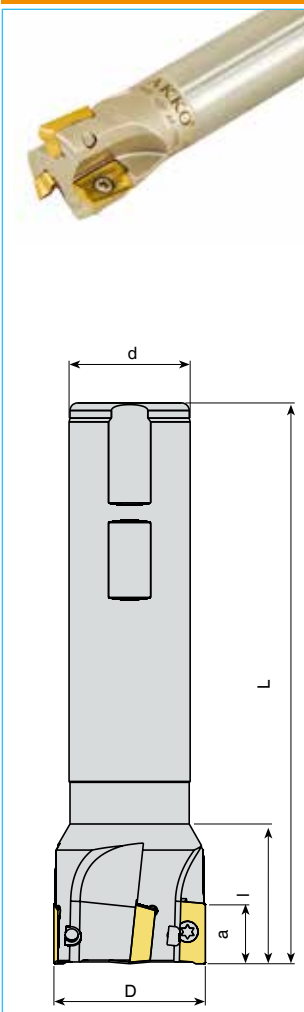

	CODE / TYP	TOOL DIMENSIONS (mm) <i>MAS</i>						CUTTING INSERT WENDE PLATTE	PRICE / PREIS
		D	Z	d	L	l	a		
	AEM90-AP16-D25-W25-L100-Z02-H	25	2	25	100	35	16		91,00 €
	AEM90-AP16-D25-W25-L150-Z02	25	2	25	150	50	16		91,00 €
	AEM90-AP16-D25-C25-L250-Z02	25	2	25	250	100	16		183,00 €
	AEM90-AP16-D28-W25-L100-Z03-H	28	3	25	100	40	16		101,00 €
	AEM90-AP16-D28-W25-L150-Z03	28	3	25	150	40	16		101,00 €
	AEM90-AP16-D30-W25-L110-Z03-H	30	3	25	110	40	16		101,00 €
	AEM90-AP16-D30-W25-L150-Z02	30	2	25	150	40	16		97,00 €
	AEM90-AP16-D30-W25-L150-Z03	30	3	25	150	40	16		101,00 €
	AEM90-AP16-D32-W32-L110-Z03-H	32	3	32	110	40	16		101,00 €
	AEM90-AP16-D32-C32-L150-Z03	32	3	32	150	50	16	AP. 1604..	101,00 €
	AEM90-AP16-D32-W25-L150-Z03	32	3	25	150	40	16	ISO	101,00 €
	AEM90-AP16-D32-W32-L150-Z03	32	3	32	150	50	16		101,00 €
	AEM90-AP16-D32-W32-L150-Z03-H	32	3	32	150	50	16		122,00 €
	<small>NEW</small> AEM90-AP16-D32-C25-L200-Z03-H	32	3	25	200	40	16		163,00 €
	AEM90-AP16-D32-C32-L250-Z02	32	2	32	250	100	16		183,00 €
	AEM90-AP16-D32-C32-L250-Z03	32	3	32	250	100	16		202,00 €
	AEM90-AP16-D35-W32-L150-Z03	35	3	32	150	40	16		106,00 €
	AEM90-AP16-D36-W32-L110-Z03-H	36	3	32	110	40	16		106,00 €
	AEM90-AP16-D36-W32-L150-Z03	36	3	32	150	40	16		106,00 €
	AEM90-AP16-D40-W32-L110-Z04-H	40	4	32	110	40	16		116,00 €
	AEM90-AP16-D40-C32-L150-Z04	40	4	32	150	40	16		116,00 €
	AEM90-AP16-D40-W32-L150-Z04	40	4	32	150	40	16		116,00 €
	AEM90-AP16-D40-C32-L250-Z02	40	2	32	250	40	16		192,00 €
	AEM90-AP16-D40-C32-L250-Z04	40	4	32	250	40	16		233,00 €
	AEM90-AP16D-D25-W25-L150-Z02	25	2	25	150	50	16		91,00 €
	AEM90-AP16D-D25-C25-L200-Z02	25	2	25	200	50	16	AP. 1604..	140,00 €
	AEM90-AP16D-D32-W32-L150-Z03	32	3	32	150	50	16	FOR DJT	101,00 €
	AEM90-AP16D-D32-C32-L180-Z03	32	3	32	180	50	16	INSERT.	175,00 €
	AEM90-AP16D-D32-C32-L200-Z03	32	3	32	200	50	16		163,00 €
	AEM90-AP16L-D25-C25-L120-Z02-H	25	2	25	120	45	16		91,00 €
	AEM90-AP16L-D25-C25-L150-Z02	25	2	25	150	55	16		91,00 €
	AEM90-AP16L-D25-C25-L200-Z02	25	2	25	200	55	16		136,00 €
	AEM90-AP16L-D25-C25-L250-Z02	25	2	25	250	100	16		183,00 €
	AEM90-AP16L-D32-C32-L120-Z03-H	32	3	32	120	45	16		101,00 €
	AEM90-AP16L-D32-C32-L150-Z03	32	3	32	150	55	16	AP. 1604..	101,00 €
	AEM90-AP16L-D32-C32-L200-Z03	32	3	32	200	55	16	FOR LMNA	150,00 €
	AEM90-AP16L-D32-C32-L250-Z03	32	3	32	250	100	16	INSERT.	202,00 €
	AEM90-AP16L-D40-C32-L120-Z04-H	40	4	32	120	40	16		116,00 €
	AEM90-AP16L-D40-C32-L150-Z04	40	4	32	150	40	16		116,00 €
	AEM90-AP16L-D40-C32-L200-Z04	40	4	32	200	40	16		172,00 €
	AEM90-AP16L-D40-C32-L250-Z04	40	4	32	250	40	16		233,00 €
	AEM90-AP16P-D25-W25-L100-Z02-H	25	2	25	100	35	16		91,00 €
	AEM90-AP16P-D25-W25-L150-Z02	25	2	25	150	50	16	AP. 1604..	91,00 €
	AEM90-AP16P-D32-W32-L150-Z03	32	3	32	150	50	16	FOR PLBT	101,00 €
	AEM90-AP16P-D32-C32-L250-Z02	32	2	32	250	100	16	INSERT.	183,00 €
AEM90-AP16P-D40-W32-L150-Z04	40	4	32	150	50	16		116,00 €	
AEM90-AP1705-D25-C25-L120-Z02	25	2	25	120	40	16		134,00 €	
AEM90-AP1705-D26-C25-L200-Z02	26	2	25	200	40	16	AP. 1705..	198,00 €	
AEM90-AP1705-D26-C25-L250-Z02	26	2	25	250	40	16	FOR TGTC-LMNA	262,00 €	
AEM90-AP1705-D28-W25-L075-Z02	28	2	25	75	20	16	INSERT.	134,00 €	
AEM90-AP1705-D32-C25-L150-Z03	32	3	25	150	40	16		145,00 €	
AEM90-AP1705-D33-C32-L300-Z02	33	2	32	300	40	16		305,00 €	

**90°**

**END MILLS / WP - SCHAFTFRÄSER**



	CODE / TYP	TOOL DIMENSIONS (mm) <small>MAß</small>						CUTTING INSERT WENDE PLATTE	PRICE / PREIS
		D	Z	d	L	l	a		
 <b>90°</b>	AEM90-AO1236-D16-C16-L85-Z02-H	16	2	16	85	30	12		113,00 €
	AEM90-AO1236-D16-W16-L150-Z02	16	2	16	150	50	12		113,00 €
	AEM90-AO1236-D20-C20-L100-Z02-H	20	2	20	100	30	12	AO.. 1236..	123,00 €
	AEM90-AO1236-D25-C25-L115-Z02-H	25	2	25	115	30	12	FOR MTSBH	134,00 €
	AEM90-AO1236-D25-W25-L150-Z03	25	3	25	150	50	12	INSERT.	138,00 €
	AEM90-AO1236-D32-W32-L150-Z04	32	4	32	150	50	12		158,00 €
 <b>90°</b>	AEM90-AX0602-D10-C10-L120-Z02	10	2	10	120	20	5.7		134,00 €
	AEM90-AX0602-D12-C12-L120-Z02	12	2	12	120	20	5.7		134,00 €
	AEM90-AX0602-D14-C12-L120-Z03	14	3	12	120	20	5.7	AX.T 0602..	150,00 €
	AEM90-AX0602-D16-W16-L120-Z04-H	16	4	16	120	20	5.7	FOR TGTC	115,00 €
	AEM90-AX0602-D16-W16-L150-Z04-H	16	4	16	150	20	5.7	INSERT.	130,00 €
	AEM90-AX0602-D20-W20-L120-Z05-H	20	5	20	120	25	5.7		136,00 €
	AEM90-AX0602-D20-W20-L150-Z05-H	20	5	20	150	25	5.7		150,00 €
	AEM90-AX0903-D16-C16-L120-Z02	16	2	16	120	30	8.8		97,00 €
	AEM90-AX0903-D16-C16-L180-Z02	16	2	16	180	30	8.8		145,00 €
	AEM90-AX0903-D17-C16-L120-Z02	17	2	16	120	25	8.8		97,00 €
	AEM90-AX0903-D17-C16-L180-Z02	17	2	16	180	25	8.8	AX.T 0903..	145,00 €
	AEM90-AX0903-D20-C20-L120-Z03	20	3	20	120	30	8.8	FOR TGTC	118,00 €
	AEM90-AX0903-D20-C20-L200-Z02	20	2	20	200	30	8.8	INSERT.	171,00 €
	AEM90-AX0903-D21-C20-L120-Z03	21	3	20	120	25	8.8		118,00 €
	AEM90-AX0903-D21-C20-L200-Z02	21	2	20	200	25	8.8		171,00 €
	AEM90-AX0903-D25-C25-L150-Z03	25	3	25	150	30	8.8		118,00 €
	AEM90-AX0903-D25-C25-L250-Z02	25	2	25	250	40	8.8		236,00 €
AEM90-AX0903-D26-C25-L150-Z03	26	3	25	150	30	8.8		118,00 €	
 <b>90°</b>	AEM90-AX1235-D16-C14-L120-Z02-H	16	2	14	120	25	10		112,00 €
	NEW AEM90-AX1235-D16-C15-L145-Z02-H	16	2	15	145	30	10		120,00 €
	NEW AEM90-AX1235-D16-C16-L100-Z02-H	16	2	16	100	30	10		112,00 €
	AEM90-AX1235-D16-C16-L140-Z02-H	16	2	16	140	30	10		112,00 €
	NEW AEM90-AX1235-D16-C16-L145-Z02-H	16	2	16	145	30	10		120,00 €
	AEM90-AX1235-D16-C16-L150-Z02	16	2	16	150	30	10		112,00 €
	NEW AEM90-AX1235-D20-C19-L150-Z02-H	20	2	19	150	40	10		128,00 €
	NEW AEM90-AX1235-D20-C20-L110-Z03-H	20	3	20	110	40	10		135,00 €
	AEM90-AX1235-D20-C20-L150-Z02	20	2	20	150	40	10	AX.T 1235..	118,00 €
	NEW AEM90-AX1235-D20-C20-L150-Z02-H	20	2	20	150	40	10	FOR SMTM	128,00 €
	AEM90-AX1235-D20-C20-L150-Z03	20	3	20	150	40	10	INSERT.	135,00 €
	AEM90-AX1235-D25-C20-L120-Z04-H	25	4	20	120	30	10		158,00 €
	NEW AEM90-AX1235-D25-C20-L150-Z04-H	25	4	20	150	30	10		158,00 €
	NEW AEM90-AX1235-D25-C24-L170-Z02-H	25	2	24	170	50	10		143,00 €
	NEW AEM90-AX1235-D25-C25-L120-Z04-H	25	4	25	120	40	10		143,00 €
	AEM90-AX1235-D25-C25-L150-Z03	25	3	25	150	50	10		142,00 €
	NEW AEM90-AX1235-D25-C25-L170-Z02-H	25	2	25	170	50	10		143,00 €
	NEW AEM90-AX1235-D25-W25-L100-Z04-H	25	4	25	100	30	10		158,00 €
	NEW AEM90-AX1235-D32-C32-L130-Z05-H	32	5	32	130	40	10		168,00 €
	NEW AEM90-AX1235-D32-C32-L180-Z02-H	32	2	32	180	50	10		150,00 €
AEM90-AX1705-D25-C25-L150-Z02	25	2	25	150	50	14	AX.T 1705..	130,00 €	
NEW AEM90-AX1705-D28-W25-L115-Z02-H	28	2	25	115	35	14	FOR SMTM	138,00 €	
AEM90-AX1705-D32-C32-L150-Z03	32	3	32	150	50	14	INSERT.	154,00 €	
NEW AEM90-AX1705-D32-C32-L180-Z02-H	32	2	32	180	50	14		170,00 €	

**END MILLS / WP - SCHAFTFRÄSER**

	CODE / TYP	TOOL DIMENSIONS (mm) <small>MAS</small>						CUTTING INSERT <small>WENDE PLATTE</small>	PRICE / PREIS
		D	Z	d	L	l	a		
 <b>90°</b>	AEM90-AZ11-D12-W16-L90-Z01	12	1	16	90	30	11		67,00 €
	AEM90-AZ11-D16-C16-L200-Z02	16	2	16	200	100	11		112,00 €
	AEM90-AZ11-D16-W15-L170-Z02	16	2	15	170	50	11		94,00 €
	AEM90-AZ11-D16-W16-L100-Z02	16	2	16	100	35	11		79,00 €
	AEM90-AZ11-D16-W16-L150-Z02	16	2	16	150	50	11		79,00 €
	AEM90-AZ11-D17-C16-L150-Z02	17	2	16	150	30	11		79,00 €
	AEM90-AZ11-D17-C16-L180-Z02	17	2	16	180	50	11		115,00 €
	AEM90-AZ11-D17-W16-L100-Z02	17	2	16	100	30	11		89,00 €
	AEM90-AZ11-D20-C20-L200-Z03	20	3	20	200	100	11	AZGT 1135..	170,00 €
	AEM90-AZ11-D20-W19-L170-Z03	20	3	19	170	50	11	FOR ZCC	109,00 €
	AEM90-AZ11-D20-W20-L110-Z02	20	2	20	110	35	11	INSERT.	91,00 €
	AEM90-AZ11-D21-C20-L150-Z03	21	3	20	150	30	11		91,00 €
	AEM90-AZ11-D21-C20-L180-Z03	21	3	20	180	50	11		117,00 €
	AEM90-AZ11-D21-W20-L110-Z03	21	3	20	110	35	11		91,00 €
	AEM90-AZ11-D25-C24-L180-Z04	25	4	24	180	50	11		157,00 €
	AEM90-AZ11-D25-W25-L110-Z04	25	4	25	110	40	11		138,00 €
	AEM90-AZ11-D26-C25-L250-Z02	26	2	25	250	50	11		204,00 €
	AEM90-AZ11-D26-W25-L120-Z03	26	3	25	120	30	11		97,00 €
AEM90-AZ11-D26-W25-L120-Z04	26	4	25	120	40	11		128,00 €	
AEM90-AZ11-D28-C25-L250-Z02	28	2	25	250	50	11		204,00 €	
AEM90-AZ11-D33-W32-L130-Z04	33	4	32	130	50	11		111,00 €	
 <b>90°</b>	AEM90-BD11T3-D16-W16-L100-Z02-H	16	2	16	100	30	10		87,00 €
	AEM90-BD11T3-D16-W16-L150-Z02	16	2	16	150	50	10		87,00 €
	AEM90-BD11T3-D17-W16-L150-Z02	17	2	16	150	50	10		97,00 €
	AEM90-BD11T3-D18-W16-L100-Z02-H	18	2	16	100	25	10		87,00 €
	AEM90-BD11T3-D20-W20-L100-Z03-H	20	3	20	100	30	10		104,00 €
	AEM90-BD11T3-D20-W20-L150-Z03	20	3	20	150	50	10		104,00 €
	AEM90-BD11T3-D21-W20-L150-Z03	21	3	20	150	50	10	BDMT 11T3..	112,00 €
	AEM90-BD11T3-D22-W20-L090-Z02-H	22	2	20	90	25	10	FOR KYCR	92,00 €
	AEM90-BD11T3-D25-W25-L100-Z03-H	25	3	25	100	30	10	INSERT.	108,00 €
	AEM90-BD11T3-D25-W25-L150-Z03	25	3	25	150	50	10		108,00 €
	AEM90-BD11T3-D26-W25-L150-Z03	26	3	25	150	50	10		112,00 €
	AEM90-BD11T3-D32-W32-L110-Z04-H	32	4	32	110	40	10		125,00 €
	AEM90-BD11T3-D32-W32-L150-Z04	32	4	32	150	50	10		125,00 €
	AEM90-BD11T3-D40-W32-L110-Z04-H	40	4	32	110	50	10		163,00 €
	AEM90-BD1704-D25-W25-L100-Z02-H	25	2	25	100	35	15.7		108,00 €
	AEM90-BD1704-D25-W25-L150-Z02	25	2	25	150	50	15.7		108,00 €
	AEM90-BD1704-D32-W32-L110-Z03-H	32	3	32	110	40	15.7	BDMT 1704..	125,00 €
	AEM90-BD1704-D32-W32-L150-Z03	32	3	32	150	50	15.7	FOR KYCR	125,00 €
AEM90-BD1704-D40-W32-L110-Z04-H	40	4	32	110	40	15.7	INSERT.	142,00 €	
AEM90-BD1704-D40-W32-L150-Z04	40	4	32	150	40	15.7		142,00 €	
 <b>90°</b>	AEM90-ED1404-D20-W20-L150-Z02	20	2	20	150	50	14.5	EDPT 1404..	112,00 €
	AEM90-ED1404-D25-W25-L150-Z02	25	2	25	150	50	14.5	FOR KNMTL	123,00 €
	AEM90-ED1404-D30-C25-L150-Z03	30	3	25	150	50	14.5	INSERT.	160,00 €

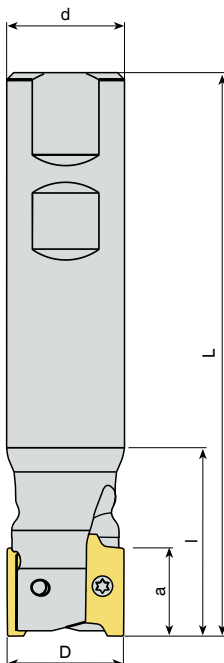

**END MILLS / WP - SCHAFTFRÄSER**

	CODE / TYP	TOOL DIMENSIONS (mm) <small>MAS</small>						CUTTING INSERT WENDE PLATTE	PRICE / PREIS
		D	Z	d	L	l	a		
    <b>90°</b>	AEM90-RT07-D10-W10-L120-Z02	10	2	10	120	30	7	RT 0702..	82,00 €
	AEM90-RT07-D12-W12-L120-Z02	12	2	12	120	30	7	FOR SFTY	82,00 €
	AEM90-RT07-D12-C12-L120-Z02	12	2	12	120	30	7	INSERT.	82,00 €
	AEM90-RT07-D14-W12-L120-Z02	14	2	12	120	30	7		82,00 €
	AEM90-RT10-D16-W16-L120-Z02-H	16	2	15	160	30	10		82,00 €
	AEM90-RT10-D16-W16-L150-Z02	16	2	16	120	30	10		82,00 €
	AEM90-RT10-D16-C15-L160-Z02	16	2	16	150	50	10		102,00 €
	AEM90-RT10-D16-C16-L200-Z02	16	2	16	200	100	10		121,00 €
	AEM90-RT10-D17-W16-L160-Z02	17	2	16	160	30	10		102,00 €
	<small>NEW</small> AEM90-RT10-D17-C16-L200-Z02	17	2	16	200	30	10		112,00 €
	AEM90-RT10-D18-W16-L120-Z02-H	18	2	16	120	30	10		82,00 €
	AEM90-RT10-D20-W20-L120-Z03-H	20	3	19	200	30	10		101,00 €
	AEM90-RT10-D20-W20-L150-Z03	20	3	20	120	30	10		101,00 €
	AEM90-RT10-D20-C19-L200-Z03	20	3	20	150	50	10	RT 1003..	163,00 €
	AEM90-RT10-D20-C20-L200-Z03	20	3	20	200	100	10	FOR SFTY	142,00 €
	AEM90-RT10-D21-W20-L200-Z03	21	3	20	200	30	10	INSERT.	169,00 €
	AEM90-RT10-D22-W20-L120-Z03-H	22	3	20	120	30	10		101,00 €
	AEM90-RT10-D22-C20-L150-Z03	22	3	20	150	30	10		101,00 €
	AEM90-RT10-D22-C20-L200-Z03	22	3	20	200	30	10		169,00 €
	AEM90-RT10-D25-W25-L120-Z04-H	25	4	25	120	40	10		111,00 €
	AEM90-RT10-D25-W25-L150-Z04	25	4	25	150	50	10		111,00 €
	AEM90-RT10-D25-C25-L200-Z04	25	4	25	200	100	10		152,00 €
	<small>NEW</small> AEM90-RT10-D26-C25-L250-Z04	26	4	25	250	32	10		194,00 €
	AEM90-RT10-D32-W32-L120-Z05-H	32	5	32	120	50	10		121,00 €
	AEM90-RT10-D32-W32-L150-Z05	32	5	32	150	50	10		121,00 €
	AEM90-RT10-D32-C32-L200-Z05	32	5	32	200	100	10		162,00 €
	<small>NEW</small> AEM90-RT10-D33-C32-L250-Z04	33	4	32	250	32	10		225,00 €
	AEM90-RT13-D32-C32-L250-Z04	32	4	32	250	50	13	RT 1304..	225,00 €
	AEM90-RT16-D25-W25-L120-Z02-H	25	2	25	120	40	16		101,00 €
	AEM90-RT16-D25-W25-L150-Z02	25	2	25	150	50	16		101,00 €
AEM90-RT16-D25-C25-L200-Z02	25	2	25	200	100	16		142,00 €	
AEM90-RT16-D32-W32-L120-Z03-H	32	3	32	120	50	16		111,00 €	
AEM90-RT16-D32-W32-L150-Z03	32	3	32	150	50	16	RT 1606..	111,00 €	
AEM90-RT16-D32-C32-L200-Z03	32	3	32	200	100	16	FOR SFTY	152,00 €	
AEM90-RT16-D32-C32-L250-Z03	32	3	32	250	100	16	INSERT.	183,00 €	
AEM90-RT16-D32-C32-L270-Z03	32	3	32	270	100	16		192,00 €	
AEM90-RT16-D40-W32-L120-Z04-H	40	4	32	120	50	16		121,00 €	
AEM90-RT16-D40-W32-L150-Z04	40	4	32	150	50	16		121,00 €	
AEM90-RT16-D40-C32-L200-Z04	40	4	32	200	100	16		162,00 €	
  <b>90°</b>	AEM90-SE09-D25-C25-L120-Z03-H	25	3	25	120	60	6.7	SEET 09T3..	102,00 €
	AEM90-SE09-D25-C25-L150-Z02	25	2	25	150	50	6.7	FOR ZCC	87,00 €
	AEM90-SE09-D32-C32-L120-Z04-H	32	4	32	120	60	6.7	INSERT.	118,00 €
	AEM90-SE09-D32-C32-L150-Z03	32	3	32	150	50	6.7		102,00 €



END MILLS / WP - SCHAFTFRÄSER

72/73



	CODE / TYP	TOOL DIMENSIONS (mm) <small>MAS</small>						CUTTING INSERT <small>WENDE PLATTE</small>	PRICE / PREIS
		D	Z	d	L	l	a		
 <b>90°</b>	AEM90-S00803-D20-C16-L110-Z02-H	20	2	16	110	25	7	SOMT 0803..	110,00 €
	AEM90-S00803-D25-C20-L110-Z02-H	25	2	20	110	25	7	FOR SMTM	119,00 €
	AEM90-S00803-D32-C25-L120-Z03-H	32	3	25	120	30	7	INSERT.	147,00 €
 <b>90°</b>	AEM90-SPGT0602-D16-W16-L150-Z02	16	2	16	150	50	5.5	SPGT 0602..	119,00 €
	AEM90-SPGT07T3-D20-W20-L150-Z03	20	3	20	150	50	7	SPGT 07T3..	133,00 €
	AEM90-SPGT07T3-D25-W25-L150-Z03	25	3	25	150	50	7	FOR ZCC INSERT.	142,00 €
	AEM90-SPGT0904-D30-W32-L150-Z03	30	3	32	150	50	9	SPGT 0904..	146,00 €
 <b>90°</b>	AEM90-XC13-D20-W20-L150-Z02	20	2	20	150	60	13	XCKX 13T3..	97,00 €
	AEM90-XC13-D25-W25-L150-Z03	25	3	25	150	60	13	FOR SC	101,00 €
	AEM90-XC13-D32-W32-L150-Z04	32	4	32	150	60	13	INSERT.	116,00 €
 <b>90°</b>	AEM90-XD11T3-D16-W16-L150-Z02	16	2	16	150	40	10		91,00 €
	AEM90-XD11T3-D17-C16-L150-Z02	17	2	16	150	30	10	XD.T 11T3..	91,00 €
	AEM90-XD11T3-D20-W20-L150-Z03	20	3	20	150	50	10	FOR CRTZT	106,00 €
	AEM90-XD11T3-D21-C20-L150-Z03	21	3	20	150	30	10	INSERT.	106,00 €
	AEM90-XD11T3-D25-W25-L150-Z04	25	4	25	150	50	10		120,00 €
	AEM90-XD11T3-D32-W32-L150-Z04	32	4	32	150	50	10		124,00 €
 <b>90°</b>	AEM90-X006-D10-C12-L120-Z02	10	2	12	120	50	5	XO.. 0602..	134,00 €
	AEM90-X006-D12-C12-L120-Z02	12	2	12	120	25	5	FOR SC INSERT.	134,00 €
	AEM90-X009-D16-W16-L150-Z02	16	2	16	150	50	8	XO.. 0903..	101,00 €
	AEM90-X009-D20-W20-L150-Z03	20	3	20	150	50	8	FOR SC INSERT.	114,00 €
	AEM90-X012-D20-W20-L150-Z02	20	2	20	150	50	11		91,00 €
	AEM90-X012-D20-C20-L200-Z02	20	2	20	200	100	11		140,00 €
	AEM90-X012-D22-W20-L150-Z02	22	2	20	150	20	11	XO.. 1204..	91,00 €
	AEM90-X012-D25-W25-L150-Z03	25	3	25	150	50	11	FOR SC	101,00 €
	AEM90-X012-D25-C25-L200-Z03	25	3	25	200	100	11	INSERT.	155,00 €
	AEM90-X012-D32-C25-L150-Z04	32	4	25	150	40	11		116,00 €
	AEM90-X012-D32-W32-L150-Z04	32	4	32	150	50	11		116,00 €
	AEM90-X012-D32-C32-L250-Z04	32	4	32	250	100	11		302,00 €

**END MILLS / WP - SCHAFTFRÄSER**

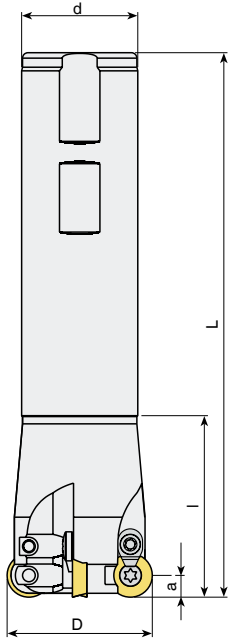

	CODE / TYP	TOOL DIMENSIONS (mm) <small>MAß</small>						CUTTING INSERT <small>WENDE PLATTE</small>	PRICE / PREIS
		D	Z	d	L	l	a		
	AEM90-ZC1003-D16-C14-L150-Z02	16	2	14	150	25	9		79,00 €
	<small>NEW</small> AEM90-ZC1003-D16-C14-L200-Z02	16	2	14	200	25	9		119,00 €
	AEM90-ZC1003-D16-C15-L150-Z02	16	2	15	150	25	9		79,00 €
	AEM90-ZC1003-D16-C16-L150-Z02	16	2	16	150	25	9		79,00 €
	AEM90-ZC1003-D17-C16-L150-Z02	17	2	16	150	25	9		79,00 €
	AEM90-ZC1003-D17-C16-L200-Z02	17	2	16	200	25	9		118,00 €
	AEM90-ZC1003-D20-C18-L150-Z03	20	3	18	150	25	9		91,00 €
	<small>NEW</small> AEM90-ZC1003-D20-C18-L200-Z02	20	2	18	200	25	9	ZCMT 100308R	132,00 €
	AEM90-ZC1003-D20-C20-L150-Z03	20	3	20	150	40	9	FOR DJT	91,00 €
	AEM90-ZC1003-D20-C18-L200-Z03	20	3	18	200	25	9	INSERT.	138,00 €
	AEM90-ZC1003-D21-C20-L150-Z03	21	3	20	150	30	9		91,00 €
	AEM90-ZC1003-D21-C20-L200-Z03	21	3	20	200	30	9		143,00 €
	AEM90-ZC1003-D25-C20-L150-Z03	25	3	20	150	30	9		91,00 €
	<small>NEW</small> AEM90-ZC1003-D25-C20-L200-Z03	25	3	20	200	30	9		91,00 €
	AEM90-ZC1003-D25-C25-L150-Z03	25	3	25	150	40	9		142,00 €
	AEM90-ZC1003-D26-C25-L170-Z03	26	3	25	170	25	9		103,00 €
	AEM90-ZC1003-D26-C25-L200-Z03	26	3	25	200	25	9		138,00 €
AEM90-ZC1003-D32-C25-L180-Z04	32	4	25	180	30	9		149,00 €	
<b>90°</b> AEM90-ZC1003-D33-C32-L200-Z04	33	4	32	200	25	9		155,00 €	
	AEM90-ZP13T3-D26-C25-L200-Z02	26	2	25	200	35	13	ZPMT 13T3..	131,00 €
	AEM90-ZP13T3-D26-C25-L200-Z03	26	3	25	200	35	13	FOR DJT	138,00 €
	AEM90-ZP13T3-D26-C25-L250-Z02	26	2	25	250	35	13	INSERT.	184,00 €
	AEM90-ZP13T3-D33-C32-L200-Z03	33	3	32	200	40	13		155,00 €
	AEM90-ZP13T3-D33-C32-L250-Z03	33	3	32	250	40	13		205,00 €
	<small>NEW</small> AEM90-3P1004-D20-W20-L150-Z02	20	2	20	150	40	7	3P.T 100408	108,00 €
	AEM90-3P1004-D25-W25-L150-Z03	25	3	25	150	40	7	FOR TGTC INSERT.	124,00 €
	AEM90-3P1505-D32-W32-L150-Z03	32	3	32	150	50	11	3P.T 150508	130,00 €
	AEM90-3P1505-D40-W32-L150-Z04	40	4	32	150	50	11	FOR TGTC	146,00 €
								INSERT.	
	<small>NEW</small> AEM90-4N06-D16-W16-L120-Z02-H	16	2	16	120	25	6	4NKT 0603..	102,00 €
	AEM90-4N06-D16-W16-L160-Z02	16	2	16	160	25	6	FOR TGTC	102,00 €
	AEM90-4N06-D20-W16-L120-Z03-H	20	3	16	120	20	6	INSERT.	128,00 €
	AEM90-4N06-D20-W16-L160-Z03	20	3	16	160	20	6		128,00 €
<b>90°</b>									

S - SYSTEM FACE AND COPY END MILLS / S-SYSTEM KOPIER - UND SCHAFTFRÄSER



74/75

	CODE / TYP	TOOL DIMENSIONS (mm) MAß					CUTTING INSERT WENDE PLATTE	PRICE / PREIS
		D	Z	d	L	I		
  	AEMR-RD0501-D08-W10-L100-Z01-H	8	1	10	100	20		93,00 €
	AEMR-RD0501-D10-W12-L100-Z02-H	10	2	12	100	20	RD.. 0501	106,00 €
	AEMR-RD0501-D12-W12-L120-Z02-H	12	2	12	120	20		106,00 €
	AEMR-RD0803-D16-W16-L150-Z02	16	2	16	150	60	RD.. 0803	84,00 €
	AEMR-RD0803-D16-C20-L200-Z02	16	2	20	200	60	ISO	131,00 €
	AEMR-RD08T2-D16-W16-L150-Z02	16	2	16	150	60	RD.. 08T2	84,00 €
	AEMR-RD08T2-D20-W20-L150-Z02	20	2	20	150	60	ISO	103,00 €
	AEMRC-RD1003-D20-W20-L150-Z02	20	2	20	150	60		103,00 €
	AEMRC-RD1003-D20-C20-L160-Z02	20	2	20	160	70		111,00 €
	AEMRC-RD1003-D20-C20-L250-Z02	20	2	20	250	150		187,00 €
	NEW AEMRC-RD1003-D21-C20-L160-Z02	21	2	20	160	70		111,00 €
	AEMRC-RD1003-D25-W25-L150-Z02	25	2	25	150	60		103,00 €
	AEMRC-RD1003-D25-C25-L160-Z02	25	2	25	160	70		111,00 €
	AEMRC-RD1003-D25-W25-L200-Z02	25	2	25	200	100		140,00 €
	AEMRC-RD1003-D25-C25-L200-Z02	25	2	25	200	100	RD.. 1003	140,00 €
	AEMRC-RD1003-D25-C25-L250-Z02	25	2	25	250	150	ISO	187,00 €
	NEW AEMRC-RD1003-D26-C25-L160-Z02	26	2	25	160	70		111,00 €
	AEMRC-RD1003-D32-W32-L150-Z03	32	3	32	150	60		116,00 €
	AEMRC-RD1003-D32-C32-L250-Z02	32	2	32	250	150		196,00 €
	NEW AEMRC-RD1003-D33-C32-L160-Z03	33	3	32	160	70		125,00 €
	AEMRC-RD1003-D40-W32-L150-Z04	40	4	32	150	35		131,00 €
	AEMRC-RD1003-D40-C32-L250-Z02	40	2	32	250	35		205,00 €
	AEMRC-RD10T3-D20-W20-L150-Z02	20	2	20	150	60	RD.. 10T3	103,00 €
	AEMRC-RD10T3-D25-W25-L150-Z02	25	2	25	150	60	ISO	103,00 €
	AEMRC-RD10T3-D32-W32-L150-Z03	32	3	32	150	60		116,00 €
	AEMRC-RD1204-D32-C32-L160-Z03	32	3	32	160	70	RD.. 1204	125,00 €
	AEMRC-RD1204-D32-W32-L160-Z03	32	3	32	160	50	ISO	125,00 €
	NEW AEMRC-RD1204-D33-C32-L160-Z03	33	3	32	160	70		125,00 €
	AEMRC-RD12T3-D25-W25-L150-Z02	25	2	25	150	60		103,00 €
	AEMRC-RD12T3-D25-W25-L200-Z02	25	2	25	200	100		140,00 €
AEMRC-RD12T3-D25-C25-L250-Z02	25	2	25	250	150		187,00 €	
AEMRC-RD12T3-D32-W32-L150-Z03	32	3	32	150	60	RD.. 12T3	116,00 €	
AEMRC-RD12T3-D32-C32-L250-Z02	32	2	32	250	150	ISO	196,00 €	
AEMRC-RD12T3-D40-W32-L150-Z04	40	4	32	150	50		131,00 €	
AEMRC-RD12T3-D40-C32-L250-Z02	40	2	32	250	50		205,00 €	
AEMRC-RD1604-D40-W32-L150-Z02	40	2	32	150	35	RD.. 1604	121,00 €	
						ISO		
	AEMR-RP10T3-D25-W25-L150-Z02	25	2	25	150	60	RPNX 10T3..	116,00 €
	AEMR-RP10T3-D32-W32-L150-Z03	32	3	32	150	60	FOR CRTZT	132,00 €
							INSERT.	

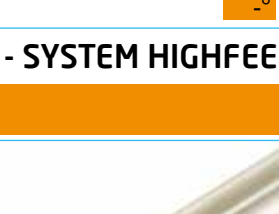
**S - SYSTEM FACE AND COPY END MILLS / S-SYSTEM KOPIER - UND SCHAFTFRÄSER**

	CODE / TYP	TOOL DIMENSIONS (mm) <small>MAß</small>					CUTTING INSERT WENDE PLATTE	PRICE / PREIS
		D	Z	d	L	I		
	AEMR-QP10T3-D20-C20-L150-Z01-H	20	1	20	150	70		134,00 €
	<small>NEW</small> AEMR-QP10T3-D25-C25-L120-Z02-H	25	2	25	120	40		156,00 €
	AEMR-QP10T3-D25-C25-L150-Z02-H	25	2	25	150	70	QP.. 10T3..	156,00 €
	AEMR-QP10T3-D25-C25-L170-Z02	25	2	25	170	90	FOR SMTM	147,00 €
	AEMR-QP10T3-D32-C32-L150-Z03-H	32	3	32	150	70	INSERT.	179,00 €
	AEMR-QP10T3-D32-C32-L170-Z03	32	3	32	170	90		158,00 €
	AEMR-QP1204-D25-C25-L150-Z02-H	25	2	25	150	70	QP.. 1204.. SMTM	156,00 €
	AEMR-RY08-D16-W16-L150-Z02	16	16	2	150	55	RYMX 0803..	107,00 €
	AEMR-RY10-D20-W20-L150-Z02	20	20	2	150	60	RYMX 1004..	117,00 €
	AEMR-RY10-D20-C20-L200-Z02	20	20	2	200	100	FOR TGTC	158,00 €
	AEMR-RY10-D25-W25-L150-Z02	25	25	2	150	60	INSERT..	128,00 €

**S - SYSTEM HIGHFEED END MILLS / S - SYSTEM HOCHGESCHWINDIGKEITS**

	CODE / TYP	TOOL DIMENSIONS (mm) <small>MAß</small>					CUTTING INSERT WENDE PLATTE	PRICE / PREIS
		D	Z	d	L	I		
	AHFM-BL0603-D17-W16-L170-Z02	17	2	16	170	20	BLMP 0603..	120,00 €
	AHFM-BL0603-D17-W16-L170-Z02-H	17	2	16	170	20	FOR TGTC	150,00 €
	<small>NEW</small> AHFM-BL0603-D18-W16-L150-Z02-H	18	2	16	150	20	INSERT.	128,00 €
	AHFM-BL0603-D21-W20-L200-Z03	21	3	20	200	25		202,00 €
	AHFM-BL0603-D26-W25-L200-Z04	26	4	25	200	35		221,00 €
	AHFM-E00602-D10-C10-L080-Z02	10	2	10	80	20		100,00 €
	AHFM-E00602-D10-C09-L120-Z02	10	2	9	120	15		100,00 €
	AHFM-E00602-D10-C10-L120-Z02	10	2	10	120	60		100,00 €
	<small>NEW</small> AHFM-E00602-D12-C12-L080-Z02	12	2	12	80	20	EO.. 0602..	100,00 €
	AHFM-E00602-D12-C12-L080-Z03	12	3	12	80	20	ZOMT 0602..	112,00 €
	AHFM-E00602-D12-C11-L120-Z02	12	2	11	120	15	FOR DJT	100,00 €
	AHFM-E00602-D12-C11-L120-Z03	12	3	11	120	15	INSERT.	112,00 €
	<small>NEW</small> AHFM-E00602-D12-C12-L120-Z02	12	2	12	120	60		100,00 €
	AHFM-E00602-D12-C12-L120-Z03	12	3	12	120	60		112,00 €
AHFM-E00602-D16-C16-L150-Z04	16	4	16	150	60		125,00 €	
	AHFM-EP1003-D16-C16-L150-Z02-H	16	2	16	150	50	EP.. 1003..	85,00 €
	AHFM-EP1003-D17-C16-L150-Z02-H	17	2	16	150	20	ZPMT 1003..	85,00 €
	AHFM-EP1003-D20-C20-L150-Z04-H	20	4	20	150	50	YPHW 1003..	117,00 €
	AHFM-EP1003-D21-C20-L150-Z04-H	21	4	20	150	20	FOR DJT	117,00 €

S - SYSTEM HIGHFEED END MILLS / S - SYSTEM HOCHGESCHWINDIGKEITS

76/77

	CODE / TYP	TOOL DIMENSIONS (mm) Maß					CUTTING INSERT WENDE PLATTE	PRICE / PREIS
		D	Z	d	L	l		
	AHFMC-JD1204-D32-C32-L150-Z02	32	2	32	150	50	JDMW 1204..	158,00 €
	AHFMC-JD1204-D32-C32-L200-Z02	32	2	32	200	50	FOR MTSBSH	209,00 €
	AHFMC-JD1204-D35-C32-L200-Z02	35	2	32	200	50	INSERT.	219,00 €
	AHFMC-JD1204-D35-C32-L250-Z02	35	2	32	250	50		301,00 €
	AHFMC-SD09T3-D25-C25-L150-Z02	25	2	25	150	100	SD.. 09T3..	117,00 €
	AHFMC-SD09T3-D25-W25-L150-Z02	25	2	25	150	100	FOR ZCC	117,00 €
	AHFMC-SD09T3-D32-C32-L150-Z03	32	3	32	150	100	INSERT.	135,00 €
	AHFMC-SD09T3-D32-W32-L150-Z03	32	3	32	150	100		135,00 €
	AHFM-SO0803-D20-W20-L150-Z02	20	2	20	150	50	SOMW 080315	112,00 €
	AHFM-SO0803-D25-W25-L150-Z03	25	3	25	150	50	FOR KPT.	122,00 €
	AHFM-SO0803-D32-W32-L150-Z04	32	4	32	150	50	INSERT.	133,00 €
	AHFM-WD0503D-D20-C20-L150-Z02	20	2	20	150	50	WDMT 0503..	95,00 €
	AHFM-WD0503D-D21-C20-L150-Z02	21	2	20	150	30	FOR DJT INSERT.	117,00 €
	AHFMC-WD06T3D-D26-C25-L200-Z02	26	2	25	200	30	WDHW 06T3..	155,00 €
	AHFMC-WD06T3D-D33-C32-L200-Z03	33	3	32	200	32	FOR DJT INSERT.	179,00 €
	NEW AHFM-WD0603-D16-C16-L150-Z02	16	2	16	150	70	WDMT 0603..	202,00 €
	AHFM-WD0603-D20-C20-L150-Z03	20	3	20	150	70	SMTM	214,00 €
	AHFMC-WD0804-D25-C25-L150-Z02	25	2	25	150	70	WDMT 0804..	154,00 €
	AHFMC-WD0804-D32-C32-L150-Z03	32	3	32	150	70	SMTM	183,00 €
	AHFMC-WD1205-D32-C32-L150-Z02	32	2	32	150	70	WDMT 1205.. FOR SMTM INSERT.	155,00 €
	AHFM-WN09T3-D25-W25-L120-Z02-H	25	2	25	120	40		138,00 €
	AHFML-WN09T3-D25-W25-L120-Z02-H	25	2	25	120	40		138,00 €
	AHFM-WN09T3-D25-C25-L200-Z02	25	2	25	200	120	WNMX 09T3..	202,00 €
	AHFM-WN09T3-D30-W25-L120-Z03-H	30	3	25	120	30	FOR KRLY	156,00 €
	AHFM-WN09T3-D32-W32-L120-Z03-H	32	3	32	120	30	INSERT.	156,00 €
	AHFM-WN09T3-D40-W32-L120-Z04-H	40	4	32	120	30		174,00 €
	AHFM-WN09T3-D40-C32-L200-Z04	40	4	32	200	30		230,00 €



MODULAR END MILLS (SCREW TYPE TOOLS) / EINSCHRAUBFRÄSER

78/79

	CODE / TYP	TOOL DIMENSIONS (mm) <small>MAß</small>						CUTTING INSERT <small>WENDE PLATTE</small>	PRICE / PREIS
		D	Z	d <sub>1</sub>	M	L	d <sub>2</sub>		
 <p>90°</p>	AEM90-AD1505D-D25-M12-L43-Z02-H	25	2	21	M12	43	12.5	ADKT 150508	132,00 €
	AEM90-AD1505D-D32-M16-L43-Z03-H	32	3	29	M16	43	17	FOR DJT INSERT.	144,00 €
 <p>90°</p>	AEM90-AX1235-D16-M08-L30-Z02-H	16	2	14.75	M08	30	8.5	AX.T 1235..	118,00 €
	AEM90-AX1235-D20-M10-L30-Z03-H	20	3	18	M10	30	10.5	FOR SMTM	135,00 €
	AEM90-AX1235-D25-M12-L35-Z04-H	25	4	21	M12	35	12.5	INSERT.	158,00 €
	AEM90-AX1705-D25-M12-L43-Z02-H	25	2	21	M12	43	12.5	AX.T 1705..	142,00 €
	AEM90-AX1705-D32-M16-L43-Z02-H	32	2	29	M16	43	17	FOR SMTM INSERT.	154,00 €
 <p>90°</p>	AEM90-DC07-D20-M10-L30-Z02-H	20	2	18	M10	30	10.5	DC.T 0702..	107,00 €
	AEM90-DC07-D25-M12-L35-Z03-H	25	3	21	M12	35	12.5	FOR ISO	122,00 €
	AEM90-DC07-D32-M16-L43-Z04-H	32	4	29	M16	43	17	INSERT.	138,00 €
	AEM90-DC07-D40-M16-L43-Z05-H	40	5	29	M16	43	17		148,00 €
	AEM90-DC11-D32-M16-L43-Z03-H-F	32	3	29	M16	43	17	DC.T 11T3..	224,00 €
	AEM90-DC11-D40-M16-L43-Z03-H-F	40	3	29	M16	43	17	FOR ISO INSERT.	224,00 €
 <p>90°</p>	AEM90-R390.11-D16-M08-L30-Z02-H	16	2	14.75	M08	30	8.5	R390-11T3..	112,00 €
	AEM90-R390.11-D20-M10-L30-Z03-H	20	3	18	M10	30	10.5	FOR SNDVK	129,00 €
	AEM90-R390.11-D25-M12-L35-Z03-H	25	3	21	M12	35	12.5	INSERT.	135,00 €
	AEM90-R390.11-D32-M16-L43-Z04-H	32	4	29	M16	43	17		146,00 €
 <p>90°</p>	AEM90-RT10-D16-M08-L20-Z02-H	16	2	14.75	M08	20	8.5	RT 1003..	110,00 €
	AEM90-RT10-D20-M10-L25-Z03-H	20	3	18	M10	25	10.5	FOR SFTY	125,00 €
	AEM90-RT10-D25-M12-L30-Z04-H	25	4	21	M12	30	12.5	INSERT.	129,00 €
	AEM90-RT10-D32-M16-L43-Z05-H	32	5	29	M16	43	17		145,00 €
	AEM90-RT10-D42-M16-L43-Z06-H	42	6	29	M16	43	17		166,00 €

**MODULAR END MILLS (SCREW TYPE TOOLS) / EINSCHRAUBFRÄSER**

	CODE / TYP	TOOL DIMENSIONS (mm) <small>MAB</small>						CUTTING INSERT WENDE PLATTE	PRICE / PREIS
		D	Z	d <sub>1</sub>	M	L	d <sub>2</sub>		
 <b>95°</b>	AEM95-XD0206-D16-M08-L23-Z02-H	16	2	14.75	M08	23	8.5		91,00 €
	AEM95-XD0206-D16-M08-L23-Z02-H-F	16	2	14.75	M08	23	8.5	XDHW 0206..	137,00 €
	AEM95-XD0206-D20-M10-L30-Z03-H	20	3	18	M10	30	10.5	FOR DJT	107,00 €
	AEM95-XD0206-D20-M10-L30-Z03-H-F	20	3	18	M10	30	10.5	INSERT.	161,00 €
	AEM95-XD0206-D25-M12-L35-Z03-H	25	3	21	M12	35	12.5		112,00 €
	AEM95-XD0206-D25-M12-L35-Z03-H-F	25	3	21	M12	35	12.5		168,00 €
	AEM95C-XD0310-D35-M16-L43-Z03-H	35	3	29	M16	43	17		129,00 €
	AEM95C-XD0310-D35-M16-L43-Z03-H-F	35	3	29	M16	43	17	XDHW 0310..	193,00 €
	AEM95C-XD0310-D42-M16-L43-Z04-H	42	4	29	M16	43	17	FOR DJT	150,00 €
	AEM95C-XD0310-D42-M16-L43-Z04-H-F	42	4	29	M16	43	17	INSERT.	225,00 €
 <b>110°</b>	AEMR-RC10T3-D25-M12-L35-Z03-H	25	3	21	M12	35	12.5	RC.. 10T3..	134,00 €
	AEMR-RC10T3-D32-M16-L43-Z04-H	32	4	29	M16	43	17	FOR ZCC	148,00 €
	AEMR-RC10T3-D40-M16-L43-Z05-H	40	5	29	M16	43	17	INSERT.	164,00 €
 <b>118°</b>	AEMR-RP08T2M-D20-M10-L30-Z02-H	20	2	18	M10	30	10.5	RPMT 08T2..	123,00 €
	AEMR-RP10T3M-D25-M12-L35-Z02-H	25	2	21	M12	35	12.5	RPMT 10T3..	128,00 €
	<small>NEW</small> AEMR-RP10T3M-D32-M16-L43-Z03-H	32	3	29	M16	43	17	MTSBSH	144,00 €
	AEMR-RP1204M-D32-M16-L43-Z03-H	32	3	29	M16	43	17	RPMT 1204..	144,00 €
	AEMR-RP1204M-D40-M16-L43-Z04-H	40	4	29	M16	43	17	FOR MTSBSH INSERT.	164,00 €
 <b>120°</b>	AEMR-RP10T3-D25-M12-L35-Z02-H	25	2	21	M12	35	12.5	RPNX 10T3..	139,00 €
	AEMR-RP10T3-D32-M16-L43-Z03-H	32	3	29	M16	43	17	FOR CRTZT INSERT.	154,00 €
 <b>135°</b>	AEMR-QP10T3-D25-M12-L35-Z02-H	25	2	21	M12	35	12.5	QP.. 10T3..	154,00 €
	AEMR-QP10T3-D32-M16-L43-Z03-H	32	3	29	M16	43	17	FOR SMTM INSERT.	170,00 €





**MODULAR END MILLS (SCREW TYPE TOOLS) / EINSCHRAUBFRÄSER**

	CODE / TYP	TOOL DIMENSIONS (mm) <i>MAß</i>						CUTTING INSERT <i>WENDE PLATTE</i>	PRICE / PREIS
		D	Z	d <sub>1</sub>	M	L	d <sub>2</sub>		
	AEMR-RD07T1-D12-M07-L23-Z02-H	12	2	10	M07	23	6.5	RD.. 07T1	91,00 €
	AEMR-RD0702-D15-M08-L23-Z02-H	15	2	13	M08	23	8.5		91,00 €
	AEMR-RD0702-D16-M08-L23-Z02-H	16	2	13	M08	23	8.5		91,00 €
	AEMR-RD0702-D20-M10-L30-Z04-H	20	4	18	M10	30	10.5		112,00 €
	AEMR-RD0702-D25-M12-L35-Z05-H	25	5	21	M12	35	12.5	RD.. 0702	129,00 €
	AEMR-RD0702-D30-M16-L42-Z05-H	30	5	29	M16	42	17	ISO	140,00 €
	AEMR-RD0702-D32-M16-L43-Z05-H	32	5	29	M16	43	17		140,00 €
	AEMR-RD0702-D35-M16-L42-Z06-H	35	6	29	M16	42	17		150,00 €
	AEMR-RD0702-D42-M16-L43-Z05-H	42	5	29	M16	43	17		154,00 €
	AEMR-RD0702-D42-M16-L43-Z07-H	42	7	29	M16	43	17		173,00 €
	AEMR-RD08T2-D16-M08-L23-Z02-H	16	2	13	M08	23	8.5		108,00 €
	AEMR-RD08T2-D16-M10-L23-Z02-H	16	2	13	M10	23	10.5	RD.. 08T2	108,00 €
	AEMR-RD08T2-D20-M10-L30-Z03-H	20	3	18	M10	30	10.5	ISO	122,00 €
	AEMR-RD08T2-D25-M12-L35-Z04-H	25	4	21	M12	35	12.5		136,00 €
	AEMR-RD0803-D16-M08-L23-Z02-H	16	2	13	M08	23	8.5		108,00 €
	AEMR-RD0803-D20-M10-L30-Z03-H	20	3	18	M10	30	10.5	RD.. 0803	122,00 €
	AEMR-RD0803-D25-M12-L35-Z04-H	25	4	21	M12	35	12.5	ISO	136,00 €
	AEMR-RD1003-D20-M10-L30-Z02-H	20	2	18	M10	30	10.5		97,00 €
	AEMR-RD1003-D25-M12-L35-Z02-H	25	2	21	M12	35	12.5		107,00 €
	AEMR-RD1003-D25-M12-L35-Z03-H	25	3	21	M12	35	12.5		112,00 €
AEMR-RD1003-D30-M16-L43-Z04-H	30	4	29	M16	43	17		129,00 €	
AEMR-RD1003-D32-M16-L43-Z04-H	32	4	29	M16	43	17	RD.. 1003	129,00 €	
AEMR-RD1003-D35-M16-L43-Z04-H	35	4	29	M16	43	17	ISO	134,00 €	
AEMR-RD1003-D40-M16-L43-Z05-H	40	5	29	M16	43	17		150,00 €	
AEMR-RD1003-D42-M16-L43-Z05-H	42	5	29	M16	43	17		150,00 €	
AEMR-RD12T3-D24-M12-L35-Z02-H	24	2	21	M12	35	12.5		107,00 €	
AEMR-RD12T3-D25-M12-L35-Z02-H	25	2	21	M12	35	12.5		107,00 €	
AEMR-RD12T3-D32-M16-L43-Z03-H	32	3	29	M16	43	17		129,00 €	
AEMR-RD12T3-D35-M16-L43-Z03-H	35	3	29	M16	43	17	RD.. 12T3	134,00 €	
AEMR-RD12T3-D35-M16-L43-Z04-H	35	4	29	M16	43	17	ISO	150,00 €	
AEMR-RD12T3-D40-M16-L43-Z04-H	40	4	29	M16	43	17		150,00 €	
AEMR-RD12T3-D42-M16-L43-Z05-H	42	5	29	M16	43	17		166,00 €	
AEMR-RD1204-D32-M16-L43-Z03-H	32	3	29	M16	43	17	RD.. 1204	129,00 €	
AEMR-RD1204-D42-M16-L43-Z04-H	42	4	29	M16	43	17	ISO	150,00 €	
AEMR-RD1604-D32-M16-L43-Z02-H	32	2	29	M16	43	17	RD.. 1604	145,00 €	
AEMR-RD1604-D40-M16-L43-Z02-H	40	2	29	M16	43	17	ISO	150,00 €	
AEMR-RD1604-D42-M16-L43-Z03-H	42	3	29	M16	43	17		166,00 €	



**S - SYSTEM MODULAR (SCREW TYPE) HIGHFEED END MILLS / SYSTEM HOCHGESCHWINDIGKEITS - EINSCHRAUBFRÄSER**

	CODE / TYP	TOOL DIMENSIONS (mm) MAß						CUTTING INSERT WENDE PLATTE	PRICE / PREIS
		D	Z	d <sub>1</sub>	M	L	d <sub>2</sub>		
	AHFM-BL0603-D32-M16-L40-Z05-H	32	5	29	M16	40	17	BLMP 0603	214,00 €
	AHFM-BL0904-D42-M16-L43-Z05-H	42	5	29	M16	43	17	BLMP 0904	164,00 €
								FOR TGTC INSERT.	
	AHFM-ED0702-D12-M06-L20-Z03	12	3	10	M06	20	6.5	EDMT 0702	126,00 €
	AHFM-ED0702-D16-M08-L25-Z04-H	16	4	14.75	M08	25	8.5	JDMT 070204	146,00 €
	AHFM-ED0702-D20-M10-L30-Z05-H	20	5	18	M10	30	10.5	FOR HTCH	166,00 €
	AHFM-ED0702-D25-M12-L30-Z06-H	25	6	21	M12	30	12.5	INSERT.	190,00 €
	AHFM-ED0702-D32-M16-L30-Z08-H	32	8	29	M16	30	17		230,00 €
	AHFM-EP1003-D16-M08-L23-Z02-H	16	2	14.75	M08	23	8.5	EP. 1003..	106,00 €
	AHFM-EP1003-D20-M10-L30-Z04-H	20	4	18	M10	30	10.5	ZPMT 1003..	134,00 €
	AHFM-EP1003-D25-M12-L35-Z04-H	25	4	21	M12	35	12.5	YPHW 1003..	152,00 €
	AHFM-EP1003-D32-M16-L43-Z05-H	32	5	29	M16	43	17	FOR DJT	163,00 €
	AHFM-EP1003-D35-M16-L43-Z05-H	35	5	29	M16	43	17	INSERT.	163,00 €
	AHFM-EP1003-D42-M16-L43-Z06-H	42	6	29	M16	43	17		166,00 €
	AHFMC-JD1204-D32-M16-L43-Z02-H	32	2	29	M16	43	17	JDMW 1204..	158,00 €
	AHFMC-JD1204-D42-M16-L43-Z03-H	42	3	29	M16	43	17	FOR MTSBH	199,00 €
								INSERT.	
	AHFMC-SD09T3-D25-M12-L30-Z02-H	25	2	22	M12	30	12.5	SD.. 09T3..	143,00 €
	AHFMC-SD09T3-D32-M16-L43-Z03-H	32	3	29	M16	43	17	FOR ZCC	182,00 €
	AHFMC-SD09T3-D35-M16-L43-Z03-H	35	3	29	M16	43	17	INSERT.	182,00 €
	AHFMC-SD09T3-D40-M16-L43-Z04-H	40	4	29	M16	43	17		198,00 €
	AHFMC-SD1204-D32-M16-L43-Z02-H	32	2	29	M16	43	17	SD.. 1204..	151,00 €
	AHFMC-SD1204-D40-M16-L43-Z03-H	40	3	29	M16	43	17	FOR ZCC	175,00 €
								INSERT.	
	AHFM-SO0803-D20-M10-L30-Z02-H	20	2	18	M10	30	10.5	SOMW 080315	122,00 €
	AHFM-SO0803-D25-M12-L35-Z03-H	25	3	22	M12	35	12.5	FOR KPT.	138,00 €
	AHFM-SO0803-D32-M16-L43-Z04-H	32	4	29	M16	43	17	INSERT.	148,00 €



**S - SYSTEM MODULAR (SCREW TYPE) HIGHFEED END MILLS / SYSTEM HOCHGESCHWINDIGKEITS - EINSCHRAUBFRÄSER** 82/83

	CODE / TYP	TOOL DIMENSIONS (mm) <small>MAß</small>						CUTTING INSERT <small>WENDE PLATTE</small>	PRICE / PREIS
		D	Z	d <sub>1</sub>	M	L	d <sub>2</sub>		
	AHFMC-WD0804-D25-M12-L35-Z02-H	25	2	21	M12	35	12.5	WDMT 0804..	170,00 €
	AHFMC-WD0804-D32-M16-L35-Z03-H	32	3	29	M16	35	17	FOR SMTM INSERT.	200,00 €
	AHFM-WD0503D-D20-M10-L30-Z02-H	20	2	18	M10	30	10.5	WDMT 0503..	143,00 €
	AHFM-WD0503D-D25-M12-L35-Z03-H	25	3	21	M12	35	12.5	FOR DJT	159,00 €
	AHFM-WD0503D-D32-M16-L43-Z04-H	32	4	29	M16	43	17	INSERT.	182,00 €
	AHFM-WD0503D-D40-M16-L43-Z05-H	40	5	29	M16	43	17		190,00 €
	AHFMC-WD06T3D-D35-M16-L43-Z03-H	35	3	29	M16	43	17	WDHW 06T3..	175,00 €
	<small>NEW</small> AHFMC-WD0805D-D32-M16-L43-Z02-H	32	2	29	M16	43	17	WDHW 0805..	261,00 €
	AHFM-WN09T3-D32-M16-L40-Z03-H	32	3	29	M16	40	17	WNMX 09T3..	138,00 €
	AHFM-WN09T3-D40-M16-L40-Z04-H	40	4	29	M16	40	17	FOR KRLY INSERT.	155,00 €







**PROFILE MILLING TOOLS / KUGEL - KOPIERFRÄSER**

	CODE / TYP	CUTTING INSERT <small>WENDE PLATTE</small>	PRICE / PREIS
	APMR-P3208-D08-C10-L110	P3208 - WLTR	122,00 €
	APMR-P3210-D10-C10-L130	P3210 - WLTR	122,00 €
	APMR-P3210-D10-C12-L130	P3210 - WLTR	122,00 €
	APMR-P3212-D12-C12-L130	P3212 - WLTR	122,00 €
	APMR-P3216-D16-C16-L175	P3216 - WLTR	112,00 €
	APMR-P3220-D20-C20-L200	P3220 - WLTR	122,00 €
	APMR-P3225-D25-C25-L200	P3225 - WLTR	132,00 €
	APMR-P3232-D32-C32-L200	P3232 - WLTR	136,00 €
	APMR-R012-D12-C12-L120	ROHX 1203	108,00 €
	APMR-R012-D12-C16-L160	ZCC	112,00 €
	APMR-R016-D16-C16-L160	ROHX 1604	112,00 €
	<small>NEW</small> APMR-R016-D16-C16-L200	FOR ZCC	122,00 €
	APMR-R016-D16-C20-L200	INSERT.	122,00 €
	APMR-R020-D20-C20-L160	ROHX 2005	116,00 €
	<small>NEW</small> APMR-R020-D20-C20-L200	FOR ZCC	130,00 €
	APMR-R020-D20-C25-L220	INSERT.	136,00 €

**PROFILE MILLING TOOLS / KUGEL - KOPIERFRÄSER**

	CODE / TYP	CUTTING INSERT WENDE PLATTE	PRICE / PREIS
  	APMR-XP16-D16-C16-L150	XPHT 16R0803	112,00 €
	APMR-XP20-D20-C20-L150	XPHT 20R10T3	116,00 €
	APMR-XP25-D25-C25-L150	XPHT 25R1204	124,00 €
		FOR ZCC INSERT.	



**BALL NOSE MODULAR (SCREW TYPE) END MILLS / EINSCHRAUB - KUGELFRÄSER**

	CODE / TYP	CUTTING INSERT WENDE PLATTE	PRICE / PREIS
 	APMR-P3216-D16-M08-L25	P3216 - WLTR	128,00 €
	APMR-P3220-D20-M10-L30	P3220 - WLTR	134,00 €
	APMR-P3225-D25-M12-L35	P3225 - WLTR	144,00 €
	APMR-P3232-D32-M16-L43	P3232 - WLTR	149,00 €
		FOR WLTR INSERT.	
 	APMR-XP16-D16-M08-L25	XPHT 16R0803	138,00 €
	APMR-XP20-D20-M10-L30	XPHT 20R10T3	147,00 €
	APMR-XP25-D25-M12-L40	XPHT 25R1204	156,00 €
		FOR ZCC INSERT.	
 	APMR-SWB225-D25-M12-L35	SWB225HM-HS	170,00 €
	APMR-SWB232-D32-M16-L43	SWB232HM-HS	175,00 €
		FOR DJT INSERT.	

SCREWED TOOL HOLDERS / AUFNAHME FÜR EINSCHRAUBFRÄSER

	CODE / TYP	TOOL DIMENSIONS (mm) MAB						PRICE / PREIS
		d	M	d <sub>1</sub>	D	L	l	
	AVTT-D13-C16-M08-L100-H	16	8	8.5	13	100	40	102,00 €
	AVTT-D15-C16-M08-L130-H	16	8	8.5	15	130	70	112,00 €
	AVTT-D18-C20-M10-L130-H	20	10	10.5	18	130	70	112,00 €
	AVTT-D18-C20-M10-L160-H	20	10	10.5	18	160	80	123,00 €
	AVTT-D23-C25-M12-L150-H	25	12	12.5	23	150	70	134,00 €
	AVTT-D23-C25-M12-L200-H	25	12	12.5	23	200	100	174,00 €
	AVTT-D23-C25-M12-L250-H	25	12	12.5	23	250	150	209,00 €
	AVTT-D30-C32-M16-L150-H	32	16	17	30	150	70	138,00 €
	AVTT-D30-C32-M16-L200-H	32	16	17	30	200	100	179,00 €
	AVTT-D30-C32-M16-L250-H	32	16	17	30	250	150	215,00 €
	AVTT-D30-C32-M16-L300-H	32	16	17	30	300	200	241,00 €

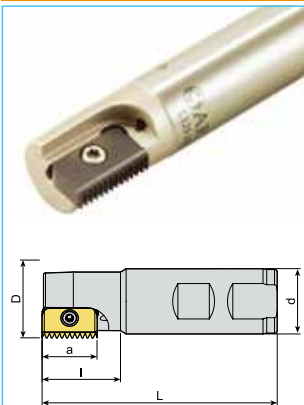
THREAD MILLING TOOLS / GEWINDEFÄHRSWERKZEUGE

	CODE / TYP	TOOL DIMENSIONS (mm) MAB						CUTTING INSERT WENDE PLATTE	PRICE / PREIS	
		D	Z	d	L	l	a			
	ATM-C14-D14-W20-L100-Z01-H	14	1	20	100	25	14	C14	102,00 €	
	ATM-C21-D18-W20-L100-Z01-H	18	1	20	100	30	21		123,00 €	
	ATM-C21-D21-W25-L125-Z01-H	21	1	25	125	40	21	C21	134,00 €	
	ATM-C21-D25-W20-L125-Z01-H	25	1	20	125	30	21	FOR CPT	134,00 €	
	ATM-C21-D28-W25-L90-Z01-H	28	1	25	90	30	21	INSERT.	168,00 €	
	ATM-C21-D38-W32-L120-Z03-H	38	3	32	120	30	21		185,00 €	
	ATM-C21-D43-W32-L90-Z03-H	43	3	32	90	30	21		199,00 €	
	ATM-C30-D29-W25-L150-Z01-H	29	1	25	150	50	30	C30	194,00 €	
								FOR CPT		
									INSERT.	
	ATM-H23-D23-C25-L100-Z02-H	23	2	25	100	30	27	H23	219,00 €	
	ATM-H32-D32-C32-L130-Z05-H	32	5	32	130	35	32	H32	255,00 €	
									FOR CPT	
								INSERT.		

	CODE / TYP	TOOL DIMENSIONS (mm) MAB						CUTTING INSERT WENDE PLATTE	PRICE / PREIS	
		α	D	d	d <sub>a</sub>	L	l			a
	ATM60-TB0601-D13-C10-L150-Z02-H	60	13	10	2.5	150	40	3.3	TBGT 060102	131,00 €
	ATM60-TC0902-D20.5-C16-L150-Z02-H	60	20.5	16	5.2	150	40	4.7	TC.T 090202	131,00 €
	ATM60-TC1102-D26-C20-L150-Z03-H	60	26	20	8.3	150	50	5.4	TC.T 110202	153,00 €
	ATM60-TC16T3-D32-C25-L150-Z02-H	60	32	25	6.4	150	50	8	TC.T 16T304	161,00 €
	ATM60-TC16T3-D40-C32-L250-Z03-H	60	40	32	13.7	250	50	8	ISO	230,00 €

**HELIX END MILL / WP - IGELFRÄSER**

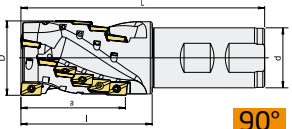
	CODE / TYP	TOOL DIMENSIONS (mm) <i>MAß</i>						CUTTING INSERT WENDE PLATTE	PRICE / PREIS
		D	z	d	a	l	L		
  <b>90°</b>	AHM90-AP10-D20-W20-L087-Z04	20	4	20	28	37	87	AP. 1003.. ISO	270,00 €
	AHM90-AP10-D20-W20-L087-Z0206-H	20	2	20	28	37	87		300,00 €
	AHM90-AP10-D25-W25-L105-Z0208-H	25	2	25	37	47	105		360,00 €
	AHM90-AP10-D32-W32-L115-Z0315-H	32	3	32	46	55	115		485,00 €
	AHM90-AP10-D40-W32-L130-Z0318-H	40	3	32	55	64	130		550,00 €

**FACE MILLING TOOLS / PLAN UND ECKMESSERKÖPFE**

	CODE / TYP	TOOL DIMENSIONS (mm) <i>MAß</i>						CUTTING INSERT WENDE PLATTE	PRICE / PREIS
		D	z	d	L	a			
 <b>42°</b>	AFM42C-XD0806-D063-A27-Z04-H	63	4	27	50	12	XDMW 0806.. FOR DJT INSERT.	182,00 €	
	AFM42C-XD0806-D080-A27-Z05-H	80	5	27	50	12		219,00 €	
	AFM42C-XD0806-D100-A32-Z06-H	100	6	32	63	12		250,00 €	
	AFM42C-XD0806-D125-B40-Z07	125	7	40	63	12		328,00 €	
	AFM42C-XD0806-D160-C40-Z08	160	8	40	63	12		401,00 €	
	AFM42C-XD0806-D200-C60-Z09	200	9	60	63	12		601,00 €	
 <b>43°</b>	AFM43-OD0504-D040-A16-Z04-H	40	4	16	40	3.5	OD.. 0504.. FOR WLTR INSERT.	102,00 €	
	AFM43-OD0504-D050-A22-Z05-H	50	5	22	40	3.5		122,00 €	
	AFM43-OD0504-D063-A22-Z06-H	63	6	22	40	3.5		143,00 €	
	AFM43-OD0504-D080-A27-Z07-H	80	7	27	50	3.5		163,00 €	
	AFM43-OD0504-D100-A32-Z08-H	100	8	32	50	3.5		205,00 €	
 <b>43°</b>	AFM43C-OD0605-D080-A27-Z06-H	80	6	27	50	4	OD.. 0605.. FOR WLTR-LMNA INSERT.	221,00 €	
	AFM43C-OD0605-D100-A32-Z07-H	100	7	32	50	4		248,00 €	
	AFM43C-OD0605-D125-B40-Z08	125	8	40	63	4		326,00 €	
 <b>43°</b>	AFM43-OF05T3-D050-A22-Z05-H	50	5	22	40	3	OF.. 05T3.. ISO	138,00 €	
	AFM43-OF05T3-D063-A22-Z06-H	63	6	22	40	3		158,00 €	
	AFM43-OF05T3-D080-A27-Z07-H	80	7	27	50	3		179,00 €	
	AFM43-OF05T3-D125-B40-Z09	125	9	40	63	3		362,00 €	

FACE MILLING TOOLS / PLAN UND ECKMESSERKÖPFE

	CODE / TYP	TOOL DIMENSIONS (mm) <small>MAß</small>					CUTTING INSERT WENDE PLATTE	PRICE / PREIS
		D	z	d	L	a		
 <p>43°</p>	AFM43-ON0604-D050-A22-Z05-H	50	5	22	40	4	ON.. 0604.. FOR ZCC INSERT.	144,00 €
	AFM43-ON0604-D063-A22-Z06-H	63	6	22	40	4		168,00 €
	AFM43-ON0604-D080-A27-Z07-H	80	7	27	50	4		195,00 €
	AFM43-ON0604-D100-A32-Z08-H	100	8	32	50	4		245,00 €
	AFM43-ON0604-D125-B40-Z09	125	9	40	63	4		326,00 €
 <p>45°</p>	AFM45-HN0905-D050-A22-Z05-H	50	5	22	40	4.5	HN.. 0905.. FOR WDA INSERT.	188,00 €
	AFM45-HN0905-D063-A22-Z06-H	63	6	22	40	4.5		211,00 €
	AFM45-HN0905-D080-A27-Z07-H	80	7	27	50	4.5		241,00 €
	NEW AFM45-HN0905-D125-B40-Z10	125	10	40	63	4.5		306,00 €
	NEW AFM45-HN0905-D160-C40-Z12	160	12	40	63	4.5		377,00 €
	NEW AFM45L-HN0905-D160-C40-Z12	160	12	40	63	4.5		377,00 €
	NEW AFM45L-HN0905-D200-C60-Z16	200	16	60	63	4.5		643,00 €
 <p>45°</p>	AFM45-SE12-D050-A22-Z04-H	50	4	22	40	6	SE.. 12T3.. FOR ZCC INSERT. R245-12T3.. FOR SNDVK INSERT. SE.. 14M4.. FOR KRLY INSERT.	122,00 €
	AFM45L-SE12-D050-A22-Z04-H	50	4	22	40	6		122,00 €
	AFM45-SE12-D063-A22-Z05-H	63	5	22	40	6		143,00 €
	AFM45L-SE12-D063-A22-Z05-H	63	5	22	40	6		143,00 €
	AFM45-SE12-D080-A27-Z06-H	80	6	27	50	6		163,00 €
	AFM45L-SE12-D080-A27-Z06-H	80	6	27	50	6		163,00 €
	AFM45-SE12-D100-A32-Z07-H	100	7	32	50	6		205,00 €
	AFM45-SE12-D125-B40-Z08	125	8	40	63	6		270,00 €
	AFM45-SE12-D160-C40-Z10	160	10	40	63	6		337,00 €
	AFM45-SE12-D200-C60-Z12	200	12	60	63	6		408,00 €
	AFM45-SE14M4-D063-A22-Z04-H	63	4	22	40	7		153,00 €
	AFM45-SE14M4-D080-A27-Z05-H	80	5	27	50	7		179,00 €
	AFM45-SE14M4-D100-A32-Z05-H	100	5	32	50	7		219,00 €
	AFM45-SE14M4-D125-B40-Z06	125	6	40	63	7		291,00 €
AFM45-SE14M4-D160-C40-Z07	160	7	40	63	7	357,00 €		
 <p>NEW</p> <p>45°</p>	AFM45-SE13-D050-A22-Z04-H	50	4	22	40	6	SEMT 13T3.. FOR SMTM-DJT INSERT.	149,00 €
	AFM45-SE13-D063-A22-Z05-H	63	5	22	40	6		175,00 €
	AFM45-SE13-D080-A27-Z06-H	80	6	27	50	6		197,00 €
	AFM45S-SE13-D050-A22-Z05-H	50	5	22	40	6		237,00 €
	AFM45S-SE13-D063-A22-Z06-H	63	6	22	40	6		277,00 €
	AFM45S-SE13-D080-A27-Z08-H	80	8	27	50	6		346,00 €
	AFM45S-SE13-D100-A32-Z10-H	100	10	32	50	6		439,00 €
	AFM45S-SE13-D125-B40-Z12	125	12	40	63	6		561,00 €

**FACE MILLING TOOLS / PLAN UND ECKMESSERKÖPFE**





	CODE / TYP	TOOL DIMENSIONS (mm) <small>MAß</small>					CUTTING INSERT WENDE PLATTE	PRICE / PREIS
		D	z	d	L	a		
 45°	AFM45-SA1706-D080-A27-Z06-H	80	6	27	50	8.4	SAKU 1706..	194,00 €
	AFM45-SA1706-D100-A32-Z07-H	100	7	32	50	8.4	FOR CRTZT	219,00 €
	AFM45-SA1706-D125-B40-Z09	125	9	40	63	8.4	INSERT.	306,00 €
 45°	AFM45C-SN12..-D050-A22-Z04-H	50	4	22	42	6		148,00 €
	AFM45C-SN12..-D050-A22-Z05-H	50	5	22	42	6		163,00 €
	AFM45C-SN12..-D063-A22-Z06-H	63	6	22	42	6		170,00 €
	AFM45C-SN12..-D063-A22-Z07-H	63	7	22	42	6		186,00 €
	AFM45CL-SN12..-D063-A22-Z07-H	63	7	22	42	6		186,00 €
	AFM45C-SN12..-D080-A27-Z07-H	80	7	27	52	6		198,00 €
	AFM45C-SN12..-D080-A27-Z08-H	80	8	27	52	6	SN.. 12....	213,00 €
	AFM45CL-SN12..-D080-A27-Z08-H	80	8	27	52	6	FOR	213,00 €
	AFM45C-SN12..-D100-A32-Z08-H	100	8	32	52	6	WLTR-LMN-ACHTK	224,00 €
	AFM45C-SN12..-D100-A32-Z10-H	100	10	32	52	6	INSERT.	242,00 €
	AFM45CL-SN12..-D100-A32-Z10-H	100	10	32	52	6		242,00 €
	AFM45C-SN12..-D125-B40-Z11	125	11	40	65	6		337,00 €
	AFM45CL-SN12..-D125-B40-Z11	125	11	40	65	6		337,00 €
	AFM45C-SN12..-D160-C40-Z12	160	12	40	65	6		415,00 €
	AFM45C-SN12..-D200-C60-Z14	200	14	60	65	6		707,00 €
AFM45CL-SN12..-D200-C60-Z14	200	14	60	65	6		707,00 €	
 45°	NEW AFM45C-SN1206-D050-A22-Z04-H	50	4	22	42	6		133,00 €
	AFM45C-SN1206-D050-A22-Z05-H	50	5	22	42	6		148,00 €
	NEW AFM45C-SN1206-D063-A22-Z06-H	63	6	22	42	6		153,00 €
	AFM45C-SN1206-D063-A22-Z07-H	63	7	22	42	6		168,00 €
	AFM45CL-SN1206-D063-A22-Z07-H	63	7	22	42	6	SN.. 1206..	168,00 €
	NEW AFM45C-SN1206-D080-A27-Z07-H	80	7	27	52	6	FOR	179,00 €
	AFM45C-SN1206-D080-A27-Z08-H	80	8	27	52	6	KRLY-PLBT-BHLR	194,00 €
	NEW AFM45CL-SN1206-D080-A27-Z08-H	80	8	27	52	6	INSERT.	194,00 €
	NEW AFM45C-SN1206-D100-A32-Z08-H	100	8	32	52	6		204,00 €
	AFM45C-SN1206-D100-A32-Z10-H	100	10	32	52	6		219,00 €
	AFM45CL-SN1206-D100-A32-Z10-H	100	10	32	52	6		219,00 €
	AFM45C-SN1206-D125-B40-Z11	125	11	40	65	6		306,00 €
	AFM45CL-SN1206-D125-B40-Z11	125	11	40	65	6		306,00 €
	AFM45C-SN1206-D160-C40-Z12	160	12	40	65	6		377,00 €
	AFM45C-SN1206-D200-C60-Z14	200	14	60	65	6		643,00 €
AFM45CL-SN1206-D200-C60-Z14	200	14	60	65	6		643,00 €	
 45°	AFM45C-SN12Z-D050-A22-Z05-H	50	5	22	42	6		148,00 €
	AFM45C-SN12Z-D063-A22-Z06-H	63	6	22	42	6	SNEG 1205..	168,00 €
	AFM45C-SN12Z-D080-A27-Z07-H	80	7	27	52	6	FOR ZCC	194,00 €
	AFM45C-SN12Z-D100-A32-Z09-H	100	9	32	52	6	INSERT.	219,00 €
	AFM45C-SN12Z-D125-B40-Z11	125	11	40	65	6		306,00 €
	NEW AFM45C-SN12Z-D160-C40-Z12	160	12	60	65	6		377,00 €
	AFM45C-SN12Z-D200-C60-Z14	200	14	60	65	6		643,00 €







**FACE MILLING TOOLS / PLAN UND ECKMESSERKÖPFE**

	CODE / TYP	TOOL DIMENSIONS (mm) <small>MAß</small>					CUTTING INSERT WENDE PLATTE	PRICE / PREIS
		D	z	d	L	a		
 <p><b>45°</b></p>	AFM45-ON0806-D063-A22-Z05-H	63	5	22	40	4	ON.. 0806..	168,00 €
	AFM45-ON0806-D080-A27-Z06-H	80	6	27	50	4		194,00 €
	AFM45-ON0806-D100-A32-Z07-H	100	7	32	50	4		219,00 €
	AFM45-ON0806-D125-B40-Z08	125	8	40	63	4		260,00 €
	AFM45-ON0806-D160-C40-Z10	160	10	40	63	4		347,00 €
	AFM45-ON0806-D200-C60-Z12	200	12	60	63	4		561,00 €
NEW AFM45-ON0806-D315-D60-Z16	315	16	60	63	4	995,00 €		
 <p><b>67°</b></p>	AFM67-PN1105-D050-A22-Z05	50	5	22	50	5	PNEG 1105.. FOR ZCC INSERT.	161,00 €
	AFM67-PN1105-D063-A22-Z06	63	6	22	50	5		188,00 €
	AFM67-PN1105-D080-A27-Z08	80	8	27	50	5		214,00 €
	AFM67-PN1105-D100-B32-Z10	100	10	32	50	5		268,00 €
	AFM67-PN1105-D125-B40-Z12	125	12	40	63	5		354,00 €
	AFM67-PN1105-D160-C40-Z14	160	14	40	63	5		536,00 €
 <p><b>75°</b></p>	AFM75-AP16-D063-A22-Z04-H	63	4	22	40	6	AP.. 1604.. ISO	134,00 €
	AFM75-AP16-D080-A27-Z05-H	80	5	27	50	6		154,00 €
	AFM75-AP16-D100-A32-Z06-H	100	6	32	50	6		185,00 €
	AFM75-AP16-D125-B40-Z07	125	7	40	63	6		245,00 €
 <p><b>75°</b></p>	NEW AFM75-X012-D050-A22-Z04-H	50	4	22	40	-	XOMX 1204.. ISO	133,00 €
	NEW AFM75-X012-D063-A22-Z05-H	63	5	22	40	-		148,00 €
	NEW AFM75-X012-D080-A27-Z06-H	80	6	27	50	-		184,00 €
 <p><b>88°</b></p>	AFM88C-SN1206-D063-A22-Z06-H	63	6	22	40	11.5	SN.. 1206.. ISO	168,00 €
	AFM88C-SN1206-D080-A27-Z07-H	80	7	27	50	11.5		195,00 €
	AFM88C-SN1206-D100-A32-Z09-H	100	9	32	52	11.5		219,00 €
 <p><b>88°</b></p>	NEW AFM88C-SN12..-D063-A22-Z06-H	63	6	22	40	11.5	SN.. 12.... ISO	186,00 €
	NEW AFM88C-SN12..-D080-A27-Z07-H	80	7	27	50	11.5		214,00 €
	NEW AFM88C-SN12..-D100-A32-Z09-H	100	9	32	52	11.5		242,00 €

**FACE MILLING TOOLS / PLAN UND ECKMESSERKÖPFE**

	CODE / TYP	TOOL DIMENSIONS (mm) <i>MAß</i>					CUTTING INSERT WENDE PLATTE	PRICE / PREIS
		D	z	d	L	a		
 <b>88°</b>	AFM88C-SN12Z-D063-A22-Z06-H	63	6	22	40	11.5	SNEG 1205..	168,00 €
	AFM88C-SN12Z-D080-A27-Z07-H	80	7	27	50	11.5	FOR ZCC INSERT.	195,00 €
 <b>90°</b>	AFM90-AD10T3-D040-A16-Z06-H	40	6	16	40	10	ADMT 10T3..	128,00 €
	AFM90-AD10T3-D050-A22-Z07-H	50	7	22	40	10	FOR WLTR INSERT.	151,00 €
 <b>90°</b>	AFM90-AD1505-D040-A16-Z04-H	40	4	16	40	15	AD.. 1505..	107,00 €
	AFM90-AD1505-D050-A22-Z05-H	50	5	22	40	15		
	AFM90-AD1505-D063-A22-Z06-H	63	6	22	40	15	FOR ISCR	148,00 €
	AFM90-AD1505-D080-A27-Z07-H	80	7	27	50	15	INSERT.	168,00 €
	AFM90-AD1505-D100-A32-Z08-H	100	8	32	50	15		205,00 €
	AFM90-AD1505-D125-B40-Z09	125	9	40	63	15		270,00 €
 <b>90°</b>	AFM90-AD1505D-D050-A22-Z05-H	50	5	22	40	14.3	ADKT 150508	128,00 €
	AFM90-AD1505D-D063-A27-Z06-H	63	6	27	50	14.3	FOR DJT	148,00 €
	AFM90-AD1505D-D080-A27-Z08-H	80	8	27	50	14.3	INSERT.	179,00 €
 <b>90°</b>	NEW AFM90-AN11-D040-A16-Z04-H	40	4	16	40	11	ANGX 1105..	125,00 €
	AFM90-AN1506-D050-A22-Z04-H	50	4	22	40	14.5		130,00 €
	AFM90-AN1506-D063-A22-Z05-H	63	5	22	40	14.5	ANGX 150608	151,00 €
	AFM90-AN1506-D080-A27-Z06-H	80	6	27	50	14.5	FOR ZCC	172,00 €
	AFM90-AN1506-D100-A32-Z08-H	100	8	32	50	14.5	INSERT.	207,00 €
	AFM90-AN1506-D125-B40-Z09	125	9	40	63	14.5		311,00 €
	AFM90-AN1506-D160-C40-Z10	160	10	40	63	14.5		403,00 €

**FACE MILLING TOOLS / PLAN UND ECKMESSERKÖPFE**

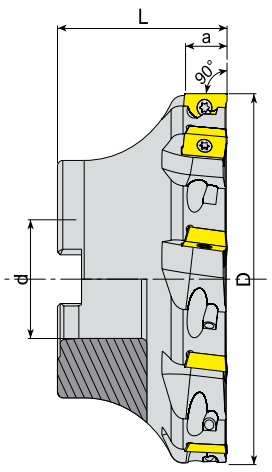
	CODE / TYP	TOOL DIMENSIONS (mm) <i>MAß</i>					CUTTING INSERT WENDE PLATTE	PRICE / PREIS
		D	z	d	L	a		
 <p>90°</p>	AFM90-AO1236-D050-A22-Z05-H	50	5	22	40	12	AO.. 1236..	153,00 €
	AFM90-AO1848-D050-A22-Z05-H	50	5	22	40	15	AO.. 1848..	153,00 €
	AFM90-AO1848-D063-A22-Z06-H	63	6	22	40	15	FOR MTSBH INSERT.	170,00 €
 <p>90°</p>	AFM90-AN1607-D050-A22-Z04-H	50	4	22	40	15	AN.X 1607..	166,00 €
	AFM90-AN1607-D063-A22-Z06-H	63	6	22	40	15	FOR TGTC	225,00 €
	AFM90-AN1607-D080-A27-Z07-H	80	7	27	50	15	INSERT.	252,00 €
	AFM90-AN1607-D100-A32-Z08-H	100	8	32	50	15		278,00 €
 <p>90°</p>	AFM90-AN12-D040-A16-Z04-H	40	4	16	40	12	ANKX 1205..	122,00 €
	AFM90-AN12-D050-A22-Z05-H	50	5	22	40	12	FOR ISCR	145,00 €
	AFM90-AN12-D063-A27-Z06-H	63	6	27	50	12	INSERT.	167,00 €
   <p>90°</p>	AFM90-AP10-D040-A16-Z05-H	40	5	16	40	10		98,00 €
	AFM90-AP10-D050-A22-Z06-H	50	6	22	40	10		118,00 €
	AFM90-AP10-D063-A22-Z07-H	63	7	22	40	10	AP.. 1003..	133,00 €
	AFM90-AP10-D080-A27-Z08-H	80	8	27	50	10	ISO	153,00 €
	AFM90-AP10-D100-A32-Z09-H	100	9	32	50	10		184,00 €
	AFM90-AP16-D040-A16-Z04-H	40	4	16	40	16		98,00 €
	AFM90-AP16-D050-A22-Z05-H	50	5	22	40	16		118,00 €
	AFM90-AP16-D052-A22-Z05-H	52	5	22	40	16		122,00 €
	AFM90-AP16-D063-A22-Z06-H	63	6	22	40	16	AP.. 1604..	133,00 €
	AFM90-AP16-D080-A27-Z07-H	80	7	27	50	16	ISO	153,00 €
	AFM90-AP16-D100-A32-Z08-H	100	8	32	50	16		184,00 €
	AFM90-AP16-D125-B40-Z09	125	9	40	63	16		245,00 €
	AFM90-AP16-D160-C40-Z10	160	10	40	63	16		306,00 €
	AFM90-AP16-D200-C60-Z12	200	12	60	63	16		510,00 €
	NEW AFM90-AP16DJ-D050-A22-Z05-H	50	5	22	40	16		118,00 €
	NEW AFM90-AP16DJ-D063-A22-Z06-H	63	6	22	40	16	AP.. 1604..	133,00 €
	NEW AFM90-AP16DJ-D080-A27-Z07-H	80	7	27	50	16	FOR DJT INSERT.	153,00 €
	AFM90-AP16L-D050-A22-Z05-H	50	5	22	40	16	AP.. 1604..	118,00 €
	AFM90-AP16L-D063-A22-Z06-H	63	6	22	40	16	FOR LMNA	133,00 €
	AFM90-AP16L-D080-A27-Z07-H	80	7	27	50	16	INSERT.	153,00 €
	AFM90-AP16P-D040-A16-Z04-H	40	4	16	40	16		98,00 €
	AFM90-AP16P-D050-A22-Z05-H	50	5	22	40	16	AP.. 1604..	118,00 €
AFM90-AP16P-D063-A22-Z06-H	63	6	22	40	16	FOR PLBT	133,00 €	
AFM90-AP16P-D080-A27-Z07-H	80	7	27	50	16	INSERT.	153,00 €	
AFM90-AP16P-D100-A32-Z08-H	100	8	32	50	16		184,00 €	

**FACE MILLING TOOLS / PLAN UND ECKMESSERKÖPFE**

	CODE / TYP	TOOL DIMENSIONS (mm) <small>MAß</small>					CUTTING INSERT <small>WENDE PLATTE</small>	PRICE / PREIS
		D	z	d	L	a		
 90°	AFM90-AP1705-D050-A22-Z05-H	50	5	22	40	16	AP.. 1705..	128,00 €
	AFM90-AP1705-D063-A22-Z06-H	63	6	22	40	16	FOR TGTC-LMNA	148,00 €
	AFM90-AP1705-D080-A27-Z07-H	80	7	27	50	16	INSERT.	168,00 €
	AFM90-AP1705-D100-A32-Z08-H	100	8	32	50	16		205,00 €
 90°	NEW AFM90-AX1235-D040-A16-Z06-H	40	6	16	40	10	AX.T 1235..	128,00 €
	NEW AFM90-AX1235-D050-A22-Z07-H	50	7	22	40	10	FOR SMTM	148,00 €
	NEW AFM90-AX1235-D063-A22-Z08-H	63	8	22	40	10	INSERT.	168,00 €
	NEW AFM90-AX1235-D080-A27-Z10-H	80	10	27	50	10		213,00 €
	AFM90-AX1705-D040-A16-Z04-H	40	4	16	40	14		112,00 €
	AFM90-AX1705-D050-A22-Z05-H	50	5	22	40	14	AX.T 1705..	135,00 €
	AFM90-AX1705-D063-A22-Z06-H	63	6	22	40	14	FOR SMTM	154,00 €
	AFM90-AX1705-D080-A27-Z07-H	80	7	27	50	14	INSERT.	176,00 €
AFM90-AX1705-D100-A32-Z08-H	100	8	32	50	14		211,00 €	
 90°	AFM90-BD1704-D050-A22-Z05-H	50	5	22	40	15.7	BDMT 1704..	132,00 €
	AFM90-BD1704-D063-A22-Z06-H	63	6	22	40	15.7	FOR KYCR	145,00 €
	AFM90-BD1704-D080-A27-Z07-H	80	7	27	50	15.7	INSERT.	167,00 €
 90°	NEW AFM90-LN1106-D050-A22-Z05	50	5	22	40	10		145,00 €
	NEW AFM90-LN1106-D063-A22-Z06	63	6	22	40	10		168,00 €
	NEW AFM90-LN1106-D080-A27-Z08	80	8	27	50	10	LNMT 1106..	213,00 €
	NEW AFM90L-LN1106-D080-A27-Z08	80	8	27	50	10	FOR ISCR	213,00 €
	NEW AFM90-LN1106-D100-A32-Z09	100	9	32	50	10	INSERT.	261,00 €
	NEW AFM90L-LN1106-D100-A32-Z09	100	9	32	50	10		261,00 €
	NEW AFM90-LN1106-D125-B40-Z10	125	10	40	63	10		339,00 €
	NEW AFM90-LN1306-D040-A16-Z04-H	40	4	16	40	12.5		122,00 €
	NEW AFM90-LN1306-D050-A22-Z05-H	50	5	22	40	12.5	LNMT 1306..	145,00 €
	NEW AFM90-LN1306-D063-A22-Z06-H	63	6	22	40	12.5	FOR ISCR	168,00 €
	NEW AFM90-LN1306-D080-A27-Z07-H	80	7	27	50	12.5	INSERT.	213,00 €
	NEW AFM90-LN1306-D100-A32-Z08-H	100	8	32	50	12.5		261,00 €
	NEW AFM90L-LN1506-D040-A16-Z04	40	4	16	40	14		122,00 €
	NEW AFM90-LN1506-D040-A16-Z04	40	4	16	40	14	LNMT 1506..	122,00 €
	NEW AFM90-LN1506-D050-A22-Z05	50	5	22	40	14	FOR ISCR	145,00 €
	NEW AFM90-LN1506-D063-A22-Z06	63	6	22	40	14	INSERT.	168,00 €
	NEW AFM90-LN1506-D080-A27-Z07	80	7	27	50	14		213,00 €
	NEW AFM90-LN1607-D050-A22-Z03-H	50	3	22	40	16		145,00 €
	NEW AFM90-LN1607-D063-A22-Z04	63	4	22	40	16	LNHT 1607..	168,00 €
	NEW AFM90-LN1607-D080-A27-Z05	80	5	27	50	16	FOR ISCR	213,00 €
NEW AFM90-LN1607-D100-A32-Z06-H	100	6	32	50	16	INSERT.	261,00 €	

**FACE MILLING TOOLS / PLAN UND ECKMESSERKÖPFE**

	CODE / TYP	TOOL DIMENSIONS (mm) <small>MAß</small>					CUTTING INSERT WENDE PLATTE	PRICE / PREIS
		D	z	d	L	a		
 <p>90°</p>	AFM90-LN1307-D050-A22-Z04-H	50	4	22	40	13	LNGX 1307..	186,00 €
	AFM90-LN1307-D063-A22-Z06-H	63	6	22	40	13	FOR WLTR	223,00 €
	AFM90-LN1307-D080-A27-Z07-H	80	7	27	50	13	INSERT.	244,00 €
	AFM90-LN1307-D100-A32-Z08-H	100	8	32	50	13		264,00 €
 <p>90°</p>	AFM90-LN15Z-D050-A22-Z04	50	4	22	40	15	LNKT 1506..	145,00 €
	AFM90-LN15Z-D063-A22-Z05	63	5	22	40	15	FOR ZCC	168,00 €
	AFM90-LN15Z-D080-A27-Z06	80	6	27	50	15	INSERT.	193,00 €
	AFM90-LN15Z-D100-A32-Z07	100	7	32	50	15		241,00 €
	AFM90-LN15Z-D125-B40-Z08	125	8	40	63	15		318,00 €
 <p>90°</p>	AFM90-LN15T6-D050-A22-Z05-H	50	5	22	40	15.5	LNGU 15T6..	145,00 €
	AFM90-LN15T6-D063-A22-Z06-H	63	6	22	40	15.5	FOR KNMTL	167,00 €
	AFM90-LN15T6-D080-A27-Z07-H	80	7	27	50	15.5	INSERT.	190,00 €
 <p>90°</p>	AFM90-R290.12-D050-A22-Z04-H	50	4	22	40	10.7		122,00 €
	AFM90-R290.12-D063-A22-Z05-H	63	5	22	40	10.7	R290-12T3..	143,00 €
	AFM90-R290.12-D080-A27-Z07-H	80	7	27	50	10.7	FOR SNDVK	163,00 €
	AFM90-R290.12-D100-A32-Z09-H	100	9	32	50	10.7	INSERT.	205,00 €
	AFM90-R290.12-D125-B40-Z11	125	11	40	63	10.7		270,00 €

Cutting Calculation : P 104 / Schnittdatenberechnung : S 104







Ordering Example/Beispiel Bestellformular: 1pcs. AFM90-LN1307-D050-A22-Z04-H



**FACE MILLING TOOLS / PLAN UND ECKMESSERKÖPFE**

	CODE / TYP	TOOL DIMENSIONS (mm) <small>MAß</small>					CUTTING INSERT WENDE PLATTE	PRICE / PREIS
		D	z	d	L	a		
  <b>90°</b>	AFM90-R390.11-D040-A16-Z05-H	40	5	16	40	10	R390-11T3..	107,00 €
	AFM90-R390.11-D050-A22-Z06-H	50	6	22	40	10	FOR SNDVK	128,00 €
	AFM90-R390.11-D063-A22-Z07-H	63	7	22	40	10	INSERT.	148,00 €
	AFM90-R390.11-D080-A27-Z09-H	80	9	27	50	10		193,00 €
	AFM90-R390.17-D040-A16-Z04-H	40	4	16	40	15.4		107,00 €
	AFM90-R390.17-D050-A22-Z05-H	50	5	22	40	15.4	R390-1704..	128,00 €
	AFM90-R390.17-D063-A22-Z06-H	63	6	22	40	15.4	FOR SNDVK	148,00 €
	AFM90-R390.17-D080-A27-Z07-H	80	7	27	50	15.4	INSERT.	168,00 €
	AFM90-R390.17-D100-A32-Z08-H	100	8	32	50	15.4		205,00 €
	AFM90-R390.17-D125-B40-Z09	125	9	40	63	15.4		270,00 €
	AFM90-R390.18-D050-A22-Z04-H	50	4	22	40	15.4		128,00 €
	AFM90-R390.18-D063-A22-Z05-H	63	5	22	40	15.4	R390-1806..	148,00 €
	AFM90-R390.18-D080-A27-Z06-H	80	6	27	50	15.4	FOR SNDVK	168,00 €
	AFM90-R390.18-D100-A32-Z07-H	100	7	32	50	15.4	INSERT.	205,00 €
AFM90-R390.18-D125-B40-Z08	125	8	40	63	15.4		270,00 €	
 <b>90°</b>	AFM90-490R14-D050-A22-Z04-H	50	4	22	40	10	490R-1404..	168,00 €
	AFM90-490R14-D063-A22-Z05-H	63	5	22	40	10	FOR SNDVK	197,00 €
	AFM90-490R14-D080-A27-Z07-H	80	7	27	50	10	INSERT.	224,00 €
 <b>90°</b>	AFM90-RT10-D040-A16-Z06-H	40	6	16	40	10	RT 1003..	107,00 €
	AFM90-RT10-D050-A22-Z07-H	50	7	22	40	10	FOR SFTY	126,00 €
	AFM90-RT10-D063-A22-Z09-H	63	9	22	50	10	INSERT.	154,00 €
 <b>90°</b>	AFM90-SD09M4-D040-A16-Z04-H	40	4	16	40	9	SD.. 09M4..	123,00 €
	AFM90-SD09M4-D050-A22-Z05-H	50	5	22	40	9	FOR KRLY	133,00 €
	AFM90-SD09M4-D063-A22-Z06-H	63	6	22	40	9	INSERT.	153,00 €
	AFM90-SD1305-D050-A22-Z04-H	50	4	22	40	13	SD.. 1305..	133,00 €
	AFM90-SD1305-D063-A22-Z05-H	63	5	22	40	13	FOR KRLY	153,00 €
	AFM90-SD1305-D080-A27-Z06-H	80	6	27	50	13	INSERT.	179,00 €
	AFM90-SD1305-D100-A32-Z07-H	100	7	32	50	13		219,00 €
	AFM90-SD1305-D125-B40-Z08	125	8	40	63	13		291,00 €
	AFM90-SD1305-D160-C40-Z10	160	10	40	63	13		357,00 €
 <b>NEW</b> <b>90°</b>	AFM90S-SD1204-D050-A22-Z04-H	50	4	22	40	11	SDMT 1204..	189,00 €
	AFM90S-SD1204-D063-A22-Z05-H	63	5	22	40	11	FOR DJT	224,00 €
	AFM90S-SD1204-D080-A27-Z06-H	80	6	27	50	11	INSERT.	250,00 €
	AFM90S-SD1204-D100-A32-Z08-H	100	8	32	50	11		321,00 €
	AFM90S-SD1204-D125-B40-Z10	125	10	40	63	11		418,00 €
	AFM90S-SD1204-D160-C40-Z12	160	12	40	63	11		520,00 €

**FACE MILLING TOOLS / PLAN UND ECKMESSERKÖPFE**

	CODE / TYP	TOOL DIMENSIONS (mm) <small>MAß</small>					CUTTING INSERT WENDE PLATTE	PRICE / PREIS
		D	z	d	L	a		
 <p>90°</p>	AFM90-SE09-D040-A16-Z04-H	40	4	16	40	6.7	SEET 09T3..	118,00 €
	AFM90-SE09-D050-A22-Z05-H	50	5	22	40	6.7	FOR ZCC	138,00 €
	AFM90-SE09-D063-A22-Z06-H	63	6	22	40	6.7	INSERT.	158,00 €
 <p>90°</p>	AFM90-SE12-D050 A22 Z04-H	50	4	22	40	12	SEET 1203..	122,00 €
	AFM90-SE12-D063 A22 Z05-H	63	5	22	40	12	FOR ZCC	163,00 €
	AFM90-SE12-D080 A27 Z07-H	80	7	27	50	12	INSERT.	205,00 €
	AFM90-SE12-D100 A32 Z09-H	100	9	32	50	12		
	AFM90-SE12-D125 B40 Z11	125	11	40	63	12		270,00 €
 <p>90°</p>	AFM90-SP1004-D040-A16-Z04-H	40	4	16	40	9.4	SPMT 1004..	123,00 €
	AFM90-SP1004-D050-A22-Z06-H	50	6	22	40	9.4	XPMT 1004.. QPMR 1004.. QPMT 1004.. FOR ISCR INSERT.	153,00 €
 <p>90°</p>	AFM90-TN2207-D063-A22-Z04-H	63	4	22	40	15	TN.X 2207..	171,00 €
	AFM90-TN2207-D080-A27-Z05-H	80	5	27	50	15	FOR TGTC	209,00 €
	AFM90-TN2207-D100-B32-Z06	100	6	32	50	15	INSERT.	252,00 €
	AFM90-TN2207-D125-B40-Z08	125	8	40	63	15		333,00 €
 <p>90°</p>	AFM90-TP2205-D063-A22-Z04	63	4	22	40	18		161,00 €
	AFM90-TP2205-D080-A27-Z06	80	6	27	50	18	TPKT 2205..	188,00 €
	AFM90-TP2205-D100-A32-Z07	100	7	32	50	18	FOR TGTC	231,00 €
	AFM90-TP2205-D125-B40-Z08	125	8	40	63	18	INSERT.	311,00 €
	AFM90-TP2205-D160-C40-Z09	160	9	40	63	18		418,00 €
	AFM90-TP2205-D200-C60-Z12	200	12	60	63	18		583,00 €
 <p>90°</p>	AFM90-WN0806-D050-A16-Z04-H	50	4	16	40	8	WNMX 080608	176,00 €
	AFM90-WN0806-D063-A22-Z05-H	63	5	22	40	8	FOR KYCR-JD	212,00 €
	AFM90-WN0806-D080-A27-Z07-H	80	7	27	50	8	INSERT.	255,00 €

**FACE MILLING TOOLS / PLAN UND ECKMESSERKÖPFE**

	CODE / TYP	TOOL DIMENSIONS (mm) <small>MAß</small>					CUTTING INSERT WENDE PLATTE	PRICE / PREIS
		D	z	d	L	a		
 90°	AFM90-XN0806-D050-A22-Z04-H	50	4	22	40	7.5	XNEX 0806..	128,00 €
	AFM90-XN0806-D063-A22-Z05-H	63	5	22	40	7.5	FOR SC	148,00 €
	AFM90-XN0806-D080-A27-Z07-H	80	7	27	50	7.5	INSERT.	189,00 €
	AFM90-XN0806-D100-A32-Z08-H	100	8	32	50	7.5		219,00 €
 90°	AFM90-X012-D040-A16-Z05-H	40	5	16	40	11		98,00 €
	AFM90-X012-D050-A22-Z07-H	50	7	22	40	11	XO.. 1204..	128,00 €
	AFM90-X012-D063-A22-Z08-H	63	8	22	40	11	FOR SC	143,00 €
	AFM90-X012-D080-A27-Z10-H	80	10	27	50	11	INSERT.	173,00 €
	AFM90-X012-D100-A32-Z12-H	100	12	32	50	11		219,00 €
 90°	AFM90-3P1004-D040-A16-Z05-H	40	5	16	40	7	3PKT 1004..	117,00 €
	AFM90-3P1004-D050-A22-Z06-H	50	6	22	40	7	TGTC	141,00 €
	AFM90-3P1505-D050-A22-Z04-H	50	4	22	40	11	3PKT 1505..	117,00 €
	AFM90-3P1505-D050-A22-Z05-H	50	5	22	40	11	FOR TGTC	138,00 €
	AFM90-3P1505-D063-A22-Z04-H	63	4	22	40	11	INSERT.	133,00 €
	AFM90-3P1505-D063-A22-Z06-H	63	6	22	40	11		148,00 €
 90°	AFM90-4N06-D040-A16-Z05-H	40	5	16	40	6	4NKT 0603..	117,00 €
	AFM90-4N06-D050-A22-Z06-H	50	6	22	40	6	FOR TGTC INSERT.	141,00 €

**FACE AND COPY MILLING TOOLS / MESSERKÖPFE FÜR RUNGE WENDESCHNEIDPLATTEN**

	CODE / TYP	TOOL DIMENSIONS (mm) <small>MAß</small>					CUTTING INSERT WENDE PLATTE	PRICE / PREIS
		D	z	d	L	a		
 -°	AFMR-RC10T3-D040-A16-Z04-H	40	4	16	40	5	RC.. 10T3..	112,00 €
	AFMR-RC10T3-D050-A22-Z05-H	50	5	22	50	5	FOR ZCC	134,00 €
	AFMR-RC10T3-D063-A22-Z06-H	63	6	22	50	5	INSERT.	154,00 €



**FACE AND COPY MILLING TOOLS / MESSERKÖPFE FÜR RUNGE WENDESCHNEIDPLATTEN**

	CODE / TYP	TOOL DIMENSIONS (mm) <small>MAß</small>					CUTTING INSERT WENDE PLATTE	PRICE / PREIS
		D	z	d	L	a		
	NEW AFMR-RC1204-D040-A16-Z04-H	40	4	16	40	6	RC.. 1204..	138,00 €
	AFMR-RC1204-D050-A22-Z05-H	50	5	22	50	6	FOR SNDVK	163,00 €
	NEW AFMR-RC1204-D052-A22-Z05-H	52	5	22	50	6	INSERT.	152,00 €
	AFMR-RC1204-D063-A22-Z06-H	63	6	22	50	6		175,00 €
	AFMR-RC1204-D080-A27-Z07-H	80	7	27	50	6		205,00 €
	AFMR-RP10T3-D063-A22-Z06-H	63	6	22	40	5	RPNX 10T3..	144,00 €
	AFMR-RP10T3-D080-A27-Z07-H	80	7	27	50	5	CRTZT	167,00 €
	AFMR-RP1204-D040-A16-Z04-H	40	4	16	40	6	RPNX 1204..	105,00 €
	AFMR-RP1204-D080-A27-Z07-H	80	7	27	50	6	FOR CRTZT	167,00 €
	NEW AFMR-RP1204M-D050-A22-Z04-H	50	4	22	50	6	RPMT 1204..	122,00 €
	NEW AFMR-RP1204M-D052-A22-Z05-H	52	5	22	50	6	FOR MTSBSH	128,00 €
	AFMR-RP1204M-D063-A22-Z05-H	63	5	22	50	6	INSERT.	132,00 €
	AFMR-RP1204M-D080-A27-Z06-H	80	6	27	50	6		153,00 €
	NEW AFMR-RY10-D040-A16-Z04-H	40	4	16	40	5	RYMX 1004..	105,00 €
	AFMR-RY10-D050-A22-Z05-H	50	5	22	50	5	FOR TGTC	133,00 €
	AFMR-RY10-D063-A22-Z06-H	63	6	22	50	5	INSERT.	163,00 €
	AFMR-RY12-D040-A16-Z04-H	40	4	16	40	6	RYMX 1205..	105,00 €
	AFMR-RY12-D050-A22-Z05-H	50	5	22	50	6	FOR TGTC	133,00 €
	AFMR-RY12-D052-A22-Z05-H	52	5	22	50	6	INSERT.	133,00 €
	AFMR-QP10T3-D040-A16-Z04-H	40	4	16	40	5	QP.. 10T3..	130,00 €
	AFMR-QP10T3-D050-A22-Z05-H	50	5	22	40	5	FOR SMTM	154,00 €
	AFMR-QP10T3-D063-A22-Z06-H	63	6	22	40	5	INSERT.	176,00 €
	AFMR-QP1204-D050-A22-Z04-H	50	4	22	40	6	QP.. 1204..	154,00 €
	AFMR-QP1204-D063-A22-Z05-H	63	5	22	40	6	FOR SMTM	176,00 €

Cutting Calculation : P 104 / Schnittdatenberechnung : S 104



Ordering Example/Beispiel Bestellformular: 1pcs. AFMR-RC1204-D040-A16-Z04-H

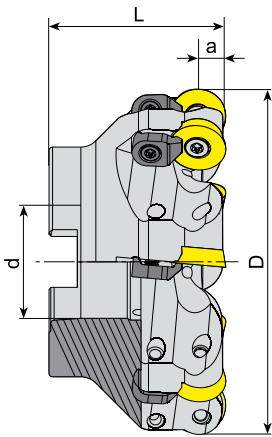

**FACE AND COPY MILLING TOOLS / MESSERKÖPFE FÜR RUNGE WENDESCHNEIDPLATTEN**



	CODE / TYP	TOOL DIMENSIONS (mm) <i>MAB</i>					CUTTING INSERT WENDE PLATTE	PRICE / PREIS
		D	z	d	L	a		
    <span style="background-color: orange; color: white; padding: 2px;">-°</span>	AFMR-RD0702-D050-A22-Z06-H	50	6	22	40	3.5	RD.. 0702..	141,00 €
	AFMR-RD0803-D050-A22-Z05-H	50	5	22	40	4	RD.. 0803..	141,00 €
	AFMRC-RD1003-D040-A16-Z04-H	40	4	16	40	5		105,00 €
	AFMRC-RD1003-D050-A22-Z05-H	50	5	22	40	5	RD.. 1003..	124,00 €
	AFMRC-RD1003-D063-A22-Z06-H	63	6	22	40	5	ISO	144,00 €
	AFMRC-RD1003-D080-A27-Z07-H	80	7	27	50	5		167,00 €
	AFMRC-RD1003-D100-A32-Z08-H	100	8	32	50	5		206,00 €
	AFMRC-RD10T3-D050-A22-Z05-H	50	5	22	50	5	RD.. 10T3..	124,00 €
	AFMRC-RD10T3-D063-A22-Z06-H	63	6	22	50	5	ISO	144,00 €
	AFMRC-RD12T3-D040-A16-Z04-H	40	4	16	40	6		105,00 €
	AFMRC-RD12T3-D050-A22-Z05-H	50	5	22	40	6		124,00 €
	AFMRC-RD12T3-D052-A22-Z05-H	52	5	22	40	6	RD.. 12T3..	124,00 €
	AFMRC-RD12T3-D063-A22-Z06-H	63	6	22	40	6	ISO	144,00 €
	AFMRC-RD12T3-D080-A27-Z07-H	80	7	27	50	6		167,00 €
	AFMRC-RD12T3-D100-A32-Z08-H	100	8	32	50	6		206,00 €
	AFMRC-RD12T3-D125-B40-Z09	125	9	40	63	6		273,00 €
	AFMRC-RD1204-D040-A16-Z04-H	40	4	16	40	6		105,00 €
	AFMRC-RD1204-D050-A22-Z05-H	50	5	22	40	6		124,00 €
	AFMRC-RD1204-D052-A22-Z05-H	52	5	22	40	6	RD.. 1204..	124,00 €
	AFMRC-RD1204-D063-A22-Z06-H	63	6	22	40	6	ISO	144,00 €
	AFMRC-RD1204-D080-A27-Z07-H	80	7	27	50	6		167,00 €
	AFMRC-RD1204-D100-A32-Z07-H	100	7	32	50	6		195,00 €
	AFMRC-RD1204-D100-A32-Z08-H	100	8	32	50	6		206,00 €
	AFMRC-RD1604-D050-A22-Z04-H	50	4	22	40	8		134,00 €
	AFMRC-RD1604-D052-A22-Z04-H	52	4	22	50	8		134,00 €
	AFMRC-RD1604-D063-A22-Z05-H	63	5	22	40	8		153,00 €
	AFMRC-RD1604-D066-A22-Z05-H	66	5	22	50	8	RD.. 1604..	153,00 €
	AFMRC-RD1604-D066-A27-Z05-H	66	5	27	50	8	ISO	153,00 €
AFMRC-RD1604-D080-A27-Z06-H	80	6	27	50	8		192,00 €	
AFMRC-RD1604-D100-A32-Z07-H	100	7	32	50	8		219,00 €	
AFMRC-RD1604-D125-B40-Z07	125	7	40	63	8		286,00 €	

**FACE MILLING TOOLS / PLAN UND ECKMESSERKÖPFE**



	CODE / TYP	TOOL DIMENSIONS (mm) <i>MAB</i>					CUTTING INSERT WENDE PLATTE	PRICE / PREIS
		D	z	d	L	a		
  <span style="background-color: orange; color: white; padding: 2px;">43°</span>	AFM43C-OF07-D063-A22-Z04	63	4	22	40	5		144,00 €
	AFM43C-OF07-D080-A27-Z05	80	5	27	50	5	OF.. 0704..	167,00 €
	AFM43C-OF07-D100-A32-Z06	100	6	32	50	5	ISO	215,00 €
	AFM43C-OF07-D125-B40-Z08	125	8	40	63	5		306,00 €
	AFM43C-OF07-D160-C40-Z09	160	9	40	63	5		377,00 €
  <span style="background-color: orange; color: white; padding: 2px;">45°</span>	AFM45C-HN0905-D063-A22-Z07	63	7	22	40	4.5		163,00 €
	AFM45C-HN0905-D080-A27-Z09	80	9	27	50	4.5	HN.. 0905..	192,00 €
	AFM45C-HN0905-D100-A32-Z11	100	11	32	50	4.5	FOR WDA-KNMTL	219,00 €
	AFM45C-HN0905-D125-B40-Z13	125	13	40	63	4.5	INSERT.	268,00 €
	AFM45CL-HN0905-D125-B40-Z10	125	10	40	63	4.5		268,00 €
	AFM45C-HN0905-D160-C40-Z15	160	15	40	63	4.5		383,00 €

FACE MILLING TOOLS / PLAN UND ECKMESSERKÖPFE

98/99

	CODE / TYP	TOOL DIMENSIONS (mm) <small>MAß</small>					CUTTING INSERT <small>WENDE PLATTE</small>	PRICE / PREIS
		D	z	d	L	a		
 <p>75°</p>	AFM75C-SP12-D050-A22-Z04	50	4	22	42	8		112,00 €
	AFM75C-SP12-D063-A22-Z05	63	5	22	40	8		128,00 €
	AFM75C-SP12-D080-A27-Z06	80	6	27	50	8		153,00 €
	AFM75C-SP12-D100-A32-Z07	100	7	32	50	8	SPKN 1203..	184,00 €
	AFM75C-SP12-D125-B40-Z08	125	8	40	63	8	ISO	245,00 €
	AFM75C-SP12-D160-C40-Z09	160	9	40	63	8		306,00 €
	AFM75C-SP12-D200-C60-Z12	200	12	60	63	8		434,00 €
 <p>90°</p>	AFM90C-TP16-D050-A22-Z04	50	4	22	40	12		112,00 €
	AFM90C-TP16-D063-A22-Z06	63	6	22	45	12		128,00 €
	AFM90C-TP16-D080-A27-Z07	80	7	27	50	12	TP.. 1603..	153,00 €
	AFM90C-TP16-D100-A32-Z08	100	8	32	50	12	ISO	184,00 €
	NEW AFM90C-TP16-D125-B40-Z08	125	8	40	63	12		245,00 €
	AFM90C-TP22-D063-A22-Z05	63	5	22	45	18		128,00 €
	AFM90C-TP22-D080-A27-Z06	80	6	27	50	18		153,00 €
	AFM90C-TP22-D100-A32-Z07	100	7	32	50	18	TP.. 2204..	184,00 €
	AFM90C-TP22-D125-B40-Z08	125	8	40	63	18	ISO	245,00 €
	AFM90C-TP22-D160-C40-Z09	160	9	40	63	18		306,00 €
	AFM90C-TP22-D200-C60-Z12	200	12	60	63	18		434,00 €
	AFM90C-TP22-D250-C60-Z15	250	15	60	63	18		612,00 €
	AFM90C-TP22-D315-D60-Z18	315	18	60	63	18		989,00 €



HIGH FEED MILLING TOOLS / HOCHVORSCHUBFRÄSER

	CODE / TYP	TOOL DIMENSIONS (mm) <small>MAß</small>					CUTTING INSERT <small>WENDE PLATTE</small>	PRICE / PREIS
		D	z	d	L	a		
 <p>°</p>	AHFM-BL0904-D050-A22-Z06-H	50	6	22	50	2	BLMP 0904..	125,00 €
	AHFM-BL0904-D063-A22-Z05-H	63	5	22	50	2	FOR TGTC	157,00 €
	AHFM-BL0904-D063-A22-Z07-H	63	7	22	50	2	INSERT.	214,00 €
 <p>°</p>	AHFM-BL1205-D050-A22-Z03-H	50	3	22	40	2	BLMP 1205..	209,00 €
	AHFM-BL1205-D063-A22-Z04-H	63	4	22	40	2	FOR TGTC	236,00 €
	AHFM-BL1205-D080-A27-Z05-H	80	5	27	50	2	INSERT.	278,00 €

**HIGH FEED MILLING TOOLS / HOCHVORSCHUBFRÄSER**

	CODE / TYP	TOOL DIMENSIONS (mm) <i>MAß</i>					CUTTING INSERT WENDE PLATTE	PRICE / PREIS
		D	z	d	L	a		
	AHFM-EP1003-D050-A22-Z08-H	50	8	22	40	1	EP.. 1003..	170,00 €
	AHFM-EP1003-D063-A22-Z08-H	63	8	22	40	1	ZPMT 1003..	179,00 €
							YPHW 1003..	
							FOR DJT INSERT.	
	AHFMC-JD1204-D052-A22-Z03-H	52	3	22	50	1.5		153,00 €
	AHFMC-JD1204-D052-A22-Z04-H	52	4	22	50	1.5	JDMW 1204..	173,00 €
	NEW AHFMC-JD1204-D063-A22-Z05-H	63	5	22	50	1.5	FOR MTSBSH	199,00 €
	NEW AHFMC-JD1204-D080-A27-Z06-H	80	6	27	50	1.5	INSERT.	235,00 €
	NEW AHFMC-JD1204-D100-A32-Z07-H	100	7	32	50	1.5		275,00 €
	AHFMC-JD1405-D052-A22-Z03-H	52	3	22	40	2	JDMW 1405..	173,00 €
AHFMC-JD1405-D063-A22-Z04-H	63	4	22	40	2	FOR MTSBSH INSERT.	204,00 €	
	AHFMC-SD1204-D050-A22-Z04-H	50	4	22	40	1.8	SD.. 1204..	151,00 €
	AHFMC-SD1204-D063-A22-Z05-H	63	5	22	40	1.8	FOR ZCC	175,00 €
	AHFMC-SD1204-D080-A27-Z06-H	80	6	27	50	1.8	INSERT.	240,00 €
	AHFMC-SD1204-D100-A32-Z08-H	100	8	32	50	1.8		291,00 €
	AHFM-SD1205-D052-A22-Z04-H	52	4	22	50	2	SD.. 1205..	180,00 €
	AHFM-SD1205-D052-A22-Z05-H	52	5	22	50	2	FOR HTCH	195,00 €
	AHFM-SD1205-D066-A22-Z05-H	66	5	22	50	2	INSERT.	219,00 €
	AHFM-SD1205-D066-A22-Z06-H	66	6	22	50	2		234,00 €
	AHFM-SD1205-D080-A27-Z06-H	80	6	27	70	2		253,00 €
	AHFMC-WD06T3D-D042-A16-Z04-H	42	4	16	45	1.5	WD.W 06T3..	155,00 €
	AHFMC-WD06T3D-D050-A22-Z05-H	50	5	22	50	1.5	FOR DJT	164,00 €
	AHFMC-WD06T3D-D052-A22-Z05-H	52	5	22	50	1.5	INSERT.	168,00 €
	AHFMC-WD0805D-D052-A22-Z04-H	52	4	22	50	2		164,00 €
	AHFMC-WD0805D-D063-A27-Z05-H	63	5	27	50	2	WD.W 0805..	186,00 €
	NEW AHFMC-WD0805D-D066-A27-Z05-H	66	5	27	50	2	FOR DJT	199,00 €
	NEW AHFMC-WD0805D-D080-A27-Z05	80	5	27	50	2	INSERT.	224,00 €
	NEW AHFMC-WD0805D-D100-A32-Z06	100	6	32	50	2		286,00 €
	NEW AHFMC-WD10X6D-D125-B40-Z06	125	6	40	63	2.5	WD.W 10X6..	314,00 €
	NEW AHFMC-WD10X6D-D160-C40-Z07	160	7	40	63	2.5	DJT INSERT.	393,00 €

**HIGH FEED MILLING TOOLS / HOCHVORSCHUBFRÄSER**

	CODE / TYP	TOOL DIMENSIONS (mm) MAß					CUTTING INSERT WENDE PLATTE	PRICE / PREIS
		D	z	d	L	a		
	AHFMC-WD0804-D040-A16-Z04-H	40	4	16	40	-	WDMT 0804..	165,00 €
	AHFMC-WD0804-D050-A22-Z04-H	50	4	22	50	-	SMTM	184,00 €
	AHFMC-WD1205-D050-A22-Z04-H	50	4	22	50	-	WDMT 1205..	170,00 €
	AHFMC-WD1205-D052-A22-Z04-H	52	4	22	50	-	FOR SMTM	170,00 €
	AHFMC-WD1205-D063-A22-Z05-H	63	5	22	50	-	INSERT.	200,00 €
	AHFMC-WD1205-D080-A27-Z06-H	80	6	27	63	-		231,00 €
	AHFMC-WD0804-D040-A16-Z04-H	40	4	16	40	1.5		159,00 €
	AHFML-WN09T3-D040-A16-Z04-H	40	4	16	40	1.5	WNMX 09T3..	159,00 €
	AHFMC-WD1205-D050-A22-Z05-H	50	5	22	40	1.5	FOR KRLY	191,00 €
	AHFML-WN09T3-D050-A22-Z05-H	50	5	22	40	1.5	INSERT.	191,00 €
	AHFMC-WD1205-D063-A22-Z06-H	63	6	22	40	1.5		215,00 €

Cutting Calculation : P 104 / Schnittdatenberechnung : S 104

Ordering Example/Beispiel Bestellformular: 1pcs. AHFMC-WD0804-D040-A16-Z04-H



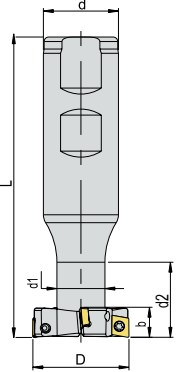

**T - SLOT MILLING / T - NUTENFRÄSER**

	CODE / TYP	TOOL DIMENSIONS (mm) <i>MAß</i>						CUTTING INSERT WENDE PLATTE	PRICE / PREIS	
		Z EFFEKTIVE	D	b	d	L	d <sub>1</sub>			d <sub>2</sub>
  <b>90°</b>	ATSM90-CC06-D17X8-W16-L85-Z02	2-1	17	8	16	85	10	16		102,00 €
	ATSM90-CC06-D28X8-W20-L66-Z04	4-2	28	8	20	66	14	15.5		158,00 €
	ATSM90-CC06-D32X8-W25-L100-Z04	4-2	32	8	25	100	16	23		135,00 €
	ATSM90-CC06-D45.5X8-W25-L100-Z06	6-3	45.5	8	25	100	12	30		240,00 €
	ATSM90-CC06-D63X8-W32-L125-Z08	8-4	63	8	32	125	31.5	30		225,00 €
	ATSM90-CC06-D18X9-W16-L90-Z02	2-1	18	9	16	90	10	16	CC.. 0602..	102,00 €
	ATSM90-CC06-D20X9-W16-L85-Z04	4-2	20	9	16	85	10	16	ISO	129,00 €
	ATSM90-CC06-D23X10-W20-L90-Z04	4-2	23	10	20	90	12	25		134,00 €
	ATSM90-CC06-D32X10-W25-L100-Z04	4-2	32	10	25	100	16	25		135,00 €
	ATSM90-CC06-D45X10-W32-L120-Z06	6-3	45	10	32	120	20	25		169,00 €
	ATSM90-CC06-D25X11-W25-L100-Z04	4-2	25	11	25	100	13	20		134,00 €
	ATSM90-CC09-D30X12-W25-L100-Z04	4-2	30	12	25	100	16	25		146,00 €
	ATSM90-CC09-D32X12-W25-L100-Z02	2-1	32	12	25	100	16	25		144,00 €
	ATSM90-CC09-D32X12-W25-L100-Z04	4-2	32	12	25	100	16	25	CC.. 09T3..	156,00 €
	ATSM90-CC09-D32X14-W25-L100-Z04	4-2	32	14	25	100	16	25	ISO	156,00 €
	ATSM90-CC09-D37X16-W32-L120-Z04	4-2	37	16	32	120	17	30		147,00 €
	ATSM90-CC09-D42X17-W32-L120-Z04	4-2	42	17	32	120	19	30		157,00 €
	ATSM90-CC09-D40X17-W32-L120-Z04	4-2	40	17	32	120	19	30		157,00 €
ATSM90-CC12-D47X20-W32-L120-Z04	4-2	47	20	32	120	25	45		169,00 €	
ATSM90-CC12-D52X21-W32-L120-Z04	4-2	52	21	32	120	25	45	CC.. 1204..	192,00 €	
ATSM90-CC12-D50X22-W32-L120-Z04	4-2	50	22	32	120	25	45	ISO	180,00 €	
ATSM90-CC12-D55X22-W32-L120-Z04	4-2	55	22	32	120	25	45		202,00 €	

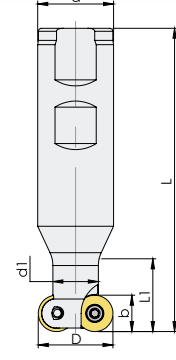
 <b>90°</b>	ATSM90-SP.05-D22.5X5-W25-L100-Z04	4-2	22.5	5	25	100	12	25	SPMG 050204	173,00 €
	ATSM90-SP.05-D30X5-W25-L100-Z04	4-2	30	5	25	100	10	25	FOR TGTC INSERT.	245,00 €
	ATSM90-SPGT0502-D63X6-W32-L125-Z10	10-5	63	6	32	125	31	30	SPGT 050204	270,00 €
	ATSM90-SPGT0904-D32X14-W32-L120-Z04-H	4-2	32	14	32	120	17.5	30	SPGT 090408	147,00 €
	ATSM90-SPGT0904-D37X16-W32-L120-Z04-H	4-2	37	16	32	120	21	40	FOR ZCC INSERT.	147,00 €
	ATSM90-SPGT0904-D42X17-W32-L120-Z04-H	4-2	42	17	32	120	21	40		157,00 €
	ATSM90-SPGT1104-D47X20-W32-L120-Z04-H	4-2	47	20	32	120	24	45	SPGT 110408	169,00 €
	ATSM90-SP.06-D80X7-W32-L120-Z10	10-5	80	7	32	120	32	30	SPMG 060204	663,00 €
								FOR TGTC INSERT.		

	CODE / TYP	TOOL DIMENSIONS (mm) <i>MAß</i>							CUTTING INSERT WENDE PLATTE	PRICE / PREIS
		Z	D	b	d	L	d <sub>1</sub>	L <sub>1</sub>		
  <b>90°</b>	ATSMR-RD0702-D17-W16-L90-Z02	2	17	7	16	90	10	12	RD.. 0702..	128,00 €
	ATSMR-RD0702-D25-W16-L90-Z03	3	25	7	16	90	15	12	ISO	148,00 €
	ATSMR-RD0702-D35-W25-L100-Z05	5	35	7	25	100	20	20		179,00 €
	ATSMR-RD1003-D21-W25-L100-Z02	2	21	10	25	100	12	20	RD.. 1003..	133,00 €
	ATSMR-RD1003-D80-W32-L165-Z06-H	6	80	10	32	165	30	31.5		734,00 €
	ATSMR-RD12T3-D25-W25-L100-Z02	2	25	12	25	100	15	24	RD.. 12T3..	138,00 €
	ATSMR-RD12T3-D80-W32-L165-Z06-H	6	80	12	32	165	30	31.5		734,00 €
	ATSMR-RD1604-D34-W32-L110-Z02	2	34	16	32	110	20	30	RD.. 1604..	143,00 €
								ISO		

**SLOT DISC MILLING / SCHEIBENFRÄSER**

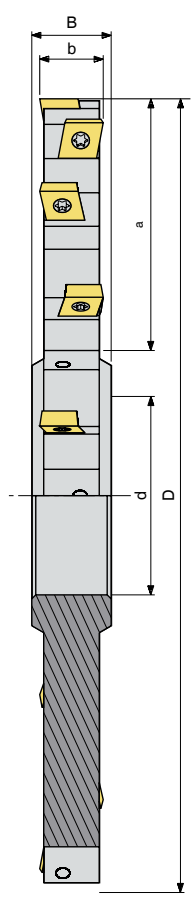
	CODE / TYP	TOOL DIMENSIONS (mm) <small>MAß</small>						CUTTING INSERT <small>WENDE PLATTE</small>	PRICE / PREIS
		<small>TOTAL EFFECTIVE</small>	D	b	a	d	B		
 <p><b>90°</b></p>	ASDM-SPGT05-D80x6-d27-Z10	10-5	80	6	17	27	10	SPGT 0502..	190,00 €
	ASDM-SPGT05-D100x6-d32-Z12	12-6	100	6	25	32	10	FOR ZCC	223,00 €
	ASDM-SPGT05-D125x6-d40-Z14	14-7	125	6	35	40	10	INSERT.	337,00 €
	ASDM-SPGT05-D160x6-d40-Z18	18-9	160	6	52	40	10		448,00 €
	ASDM-SPGT06-D80x7-d27-Z10	10-5	80	7	17	27	11		190,00 €
	ASDM-SPGT06-D100x7-d32-Z12	12-6	100	7	25	32	11	SPGT 0602..	223,00 €
	ASDM-SPGT06-D125x7-d40-Z14	14-7	125	7	35	40	11	FOR ZCC	337,00 €
	ASDM-SPGT06-D160x7-d40-Z16	16-8	160	7	52	40	11	INSERT.	448,00 €
	ASDM-SPGT06-D200x7-d40-Z18	18-9	200	7	70	40	11		560,00 €
   <p><b>90°</b></p>	ASDM-CC06-D80x8-d27-Z10	10-5	80	8	17	27	12		190,00 €
	ASDM-CC06-D100x8-d32-Z12	12-6	100	8	25	32	12		223,00 €
	ASDM-CC06-D125x8-d40-Z14	14-7	125	8	35	40	12		337,00 €
	ASDM-CC06-D160x8-d40-Z16	16-8	160	8	52	40	12		448,00 €
	ASDM-CC06-D200x8-d40-Z18	18-9	200	8	70	40	12	CC.. 0602..	560,00 €
	ASDM-CC06-D80x10-d27-Z10	10-5	80	10	17	27	14	ISO	190,00 €
	ASDM-CC06-D100x10-d32-Z12	12-6	100	10	25	32	14		223,00 €
	ASDM-CC06-D125x10-d40-Z14	14-7	125	10	35	40	14		337,00 €
	ASDM-CC06-D160x10-d40-Z16	16-8	160	10	52	40	14		448,00 €
	ASDM-CC06-D200x10-d40-Z18	18-9	200	10	70	40	14		560,00 €
	ASDM-CC09-D80x12-d27-Z08	8-4	80	12	17	27	16		190,00 €
	ASDM-CC09-D100x12-d32-Z10	10-5	100	12	25	32	16		223,00 €
	ASDM-CC09-D125x12-d40-Z12	12-6	125	12	35	40	16		337,00 €
	ASDM-CC09-D160x12-d40-Z14	14-7	160	12	52	40	16		448,00 €
	ASDM-CC09-D200x12-d40-Z16	16-8	200	12	70	40	16	CC.. 09T3..	560,00 €
	ASDM-CC09-D80x14-d27-Z08	8-4	80	14	17	27	18	ISO	190,00 €
	ASDM-CC09-D100x14-d32-Z10	10-5	100	14	25	32	18		223,00 €
	ASDM-CC09-D125x14-d40-Z12	12-6	125	14	35	40	18		337,00 €
	ASDM-CC09-D160x14-d40-Z14	14-7	160	14	52	40	18		448,00 €
	ASDM-CC09-D200x14-d40-Z16	16-8	200	14	70	40	18		560,00 €
	ASDM-CC12-D80x16-d27-Z06	6-3	80	16	17	27	20		190,00 €
	ASDM-CC12-D100x16-d32-Z08	8-4	100	16	25	32	20		223,00 €
	ASDM-CC12-D125x16-d40-Z10	10-5	125	16	35	40	20		337,00 €
	ASDM-CC12-D160x16-d40-Z12	12-6	160	16	52	40	20		448,00 €
	ASDM-CC12-D200x16-d40-Z14	14-7	200	16	70	40	20		560,00 €
	ASDM-CC12-D80x18-d27-Z06	6-3	80	18	17	27	22		190,00 €
	ASDM-CC12-D100x18-d32-Z08	8-4	100	18	25	32	22		223,00 €
	ASDM-CC12-D125x18-d40-Z10	10-5	125	18	35	40	22	CC.. 1204..	337,00 €
	ASDM-CC12-D160x18-d40-Z12	12-6	160	18	52	40	22	ISO	448,00 €
	ASDM-CC12-D200x18-d40-Z14	14-7	200	18	70	40	22		560,00 €
	ASDM-CC12-D250x18-d40-Z16	16-8	250	18	90	40	22		784,00 €
	ASDM-CC12-D80x20-d27-Z06	6-3	80	20	17	27	24		190,00 €
ASDM-CC12-D100x20-d32-Z08	8-4	100	20	25	32	24		223,00 €	
ASDM-CC12-D125x20-d40-Z10	10-5	125	20	35	40	24		337,00 €	
ASDM-CC12-D160x20-d40-Z12	12-6	160	20	52	40	24		448,00 €	
ASDM-CC12-D200x20-d40-Z14	14-7	200	20	70	40	24		560,00 €	
ASDM-CC12-D250x20-d40-Z16	16-8	250	20	90	40	24		784,00 €	

**User's Guide For AKKO U-Drills**

Before connecting your U-Drill to CNC lathe, you have to check if the turret is eccentric from the center or not. If there is any eccentricity in your turret, never use your U-Drill;

Processes that should be done to fix the turret :

1. A cylindrical part whose surface is precision and whose length and diameter is the same with the U-Drill that you will use, should be mounted to the holder of turret and X value of the lathe should be brought to zero ( 0 ).
2. Comparator should be mounted to chuck. The end of the comparator should be contacted ( touched ) to the surface of the part that we mounted on the turret.
3. The comparator that we mounted on the chuck should be turned 360-degree with the chuck and turret should be zeroed by that turning according to changing rate of comparator.

**Cutting Speed and Revolution That are Needed For Using ( Running ) Your U-DRILLS More Productively**

Grup No.	Material	Material Type	Cutting Speed Vc ( m/m)
1	Non-alloy steel and free cutting steel	C1010. Automat etc.	220
2	Low alloy steel and cast steel	C1030 - 106 etc.	200
3	Alloy steel and tool steel	CK-45, 4140, 7131 etc.	170
4	Hot Work Steel and Stainless Steel	Impax etc.	150

P.S. : The cutting speed may be concerned with the type of the insert that you use.

Fistly, choose the material to make calculation of revolution. You should multiply the cutting speed (Vc) of the material that you chose by 1000 and divide by 3.14. You should divide the value that you found by the diameter of U-Drill. For Example : If our material is alloy steel and tool steel ( 3rd group ), diameter of the U-Drill is 25 mm, cutting speed is 170, we should calculate as following:  $170 \times 1000 = 170000 / 3.14 = 54140$ ,  $54140 / 25 = 2166$  rpm is the result that we found ( Spindle Speed ) Feed rate of the lathe is concerned with the U-Drill that you will use and changes between 0.05 and 0.10. The user sets it according to cut of cutting insert.

**Feed Calculation For Central Machine :**

2166 spindle speed, that we found as a result of above mentioned calculation, should be multiplied by cutting insert feed ( mm/r ) between 0.05 and 0.10 feed choisses. Example 1 :  $2166 \times 0.05 = 108$

Example 2 :  $2116 \times 0.10 = 217$  The results 108 and 217 are the feed mm/m calculation for central machine.

Note: Cooling water pressure of lathe must be minimum 6 bar for our D4 u-drills and u-drills longer than D4.

**Calculating Spindle Speed and Feed Rate For Milling Process**

Vc.	S	D	F	Z	fz	FORMULAS
Cutting Speed (Please read from the back-side of cutting insert box)	Spindle Revolution rpm	Milling Tool Diameter	Feed Rate	Number of Effective Tooth	Feed Per Tooth (Please Read From The Back Side of Cutting Insert Box)	Calculation of Revolution : $S = (Vc \times 1000) / (3.14 \times D)$ Feed Rate Calculation : $F = S \times Z \times fz$

For Example : We will make milling with milling tool whose diamention is D 50 mm, whose theeth number is Z=5. The spindle revolution was written as Vc=200m/mn at the back side of cutting insert box. Let's calculate the revolution that should be entered to the milling machine : Vc=200 m/mn D=50 mm

S = Firstly Cutting Speed is multiplied with 1000, the result should be divided by 3.14 , the last result should be divided by diameter of milling tool.

$S = 200 \times 1000 = 200000 \rightarrow 200000 / 3.14 = 63663 \rightarrow 63663 / 50 = 1273$  rev S=1273 rev / mn

After finding spindle revolution, let's find feed rate : milling tool with Z=5 teeth and we read fz=0,12 from the back side of cutting insert box.

F = Tooth number should be multiplied with revolution, the result should be multiplied with feed per tooth.

$F = 1273 \times 5 = 6365 \rightarrow 6365 \times 0,12 = 763$  F = 763 mm / mn

Revolution that should be entered to the milling machine = S 1273 Feed Rate that should be entered to the milling machine = F 763 average value.

P.S : The values Vc and fz has to be written at the back side of the cutting insert. If these values were not written on the cutting insert box, please find them from cutting insert catalogue. If the material that you will work is steel, please read Vc and fz values that were written on the part P, if it is stainless steel please read from the part M, if it is cast iron please read from the part K.



**Recommended Tightening Torque**

- Read below information before tightening the tool.
- Check screw set's the screw size and together with mounting arbor inner dimension of screws.
- When tightening head to an arbor, follow the related tightening torque in the table.

Screw	Torque (N.m)
M6	8
M8	23
M10	46
M12	80
M16	90

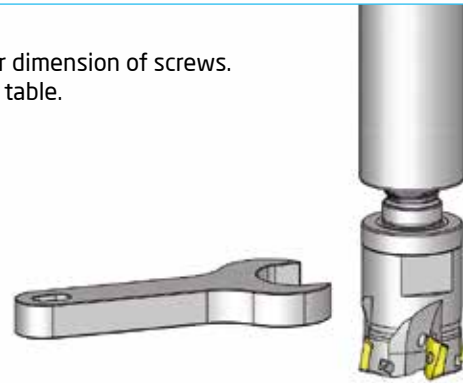

**Internal Boring Bars Application Guide, Related to Body Material**

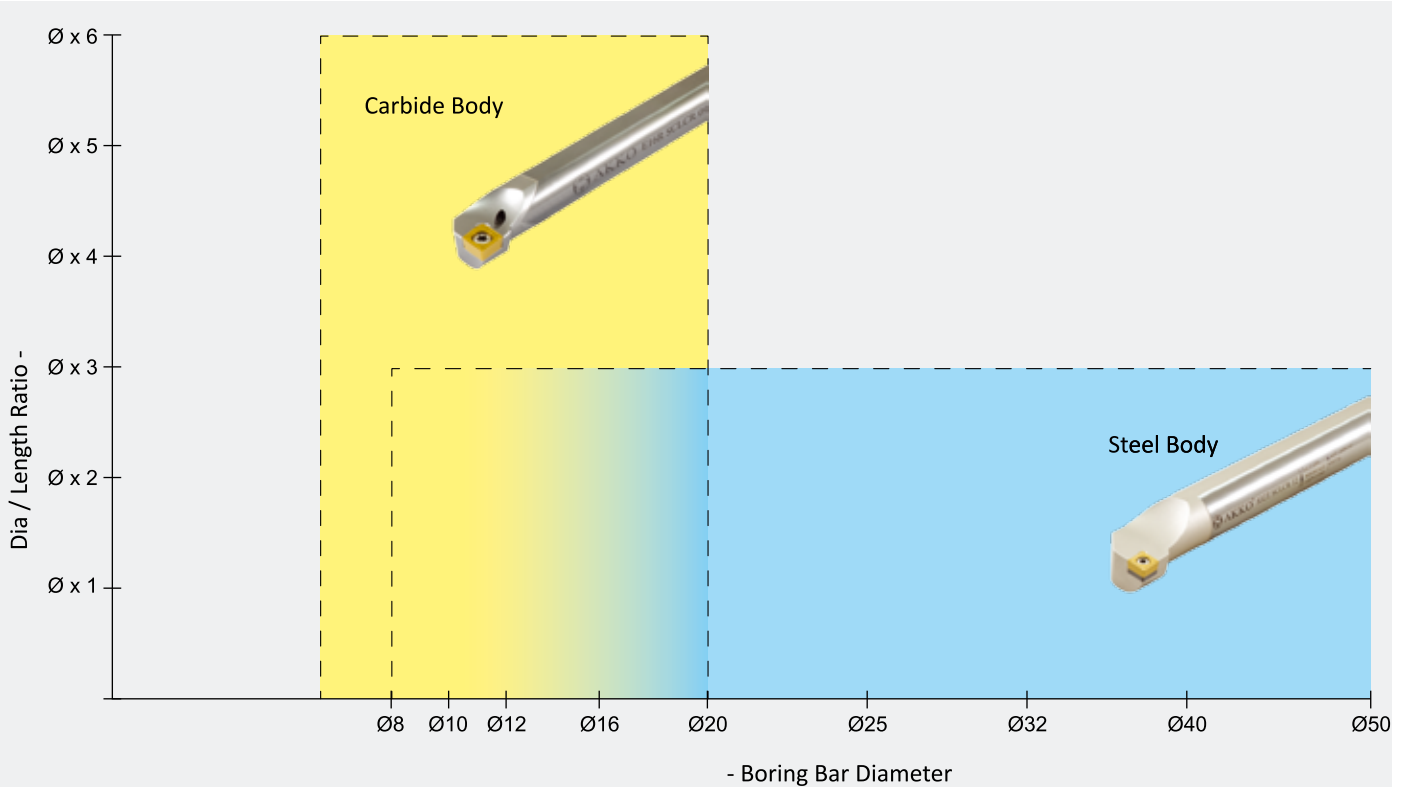

**Application Guide For T-Slot Milling**

When T slot machining steel, the workpiece must be machined as shown in the drawing to ensure smooth chip evacuation.







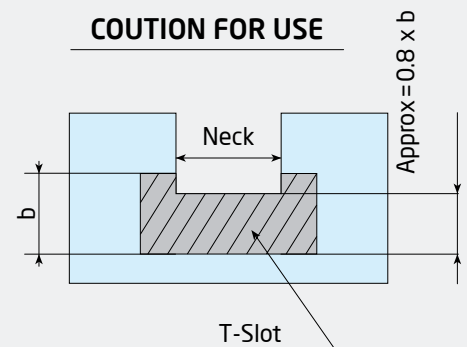



Example: Before slotting with the T - slot milling cutter - code ATSM90-CC06-D32X10-W25-L100-Z04,

The area of the neck of the tools to be worked and must be machined by End-Mill. In this case, it is very wrong to machining the slot completely. Bottom area (0.8 x b = 0.8 x 10) should be left 8 mm without machining. This area's operation must be machined by the T - slot milling cutter which is also necessary for the healthier work of the tool holder.

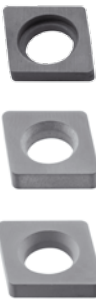
Slots to be machined must be free from chips for smooth machining.

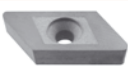

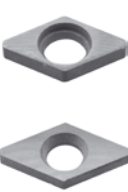
**SPARE PARTS / ERSATZTEILE**
**SHIMS**











PRODUCT PICTURE	CODE	PRODUCT DETAIL		PRICE / PREIS
	<b>AATN-2-0001</b>	For S-SYSTEM	TCMT 16 SHIM	5,40 €
	<b>AATN-2-0002</b>	For T-M SYSTEM For C-SYSTEM	TNMG 16 SHIM TNGN 16 SHIM	5,40 €
	<b>AATN-3-0025</b>	For P-SYSTEM	TNMG 16 SHIM	5,40 €
	<b>AATN-3-0015</b>	For T-M-P SYSTEM	TNMG 22 SHIM	5,60 €
	<b>AATN-2-0020</b>	For THREADING 16 SHIM		5,60 €
	<b>AATN-2-0004</b>	For THREADING 22 SHIM		7,10 €
	<b>ATS-16E</b>	For THREADING 16, EXTERNAL RIGHT - INTERNAL LEFT SHIM		8,00 €
	<b>ATS-16I</b>	For THREADING 16, EXTERNAL LEFT - INTERNAL RIGHT SHIM		8,00 €
	<b>ATS-22E</b>	For THREADING 22, EXTERNAL RIGHT - INTERNAL LEFT SHIM		11,00 €
	<b>ATS-22I</b>	For THREADING 22, EXTERNAL LEFT - INTERNAL RIGHT SHIM		11,00 €
	<b>ATS-27E</b>	For THREADING 27, EXTERNAL RIGHT - INTERNAL LEFT SHIM		20,40 €
	<b>ATS-27I</b>	For THREADING 27, EXTERNAL LEFT - INTERNAL RIGHT SHIM		20,40 €
	<b>AACN-2-0001</b>	For S-SYSTEM	CCMT 09 SHIM	5,40 €
		For T-SYSTEM	CNMG 09 SHIM	
	<b>AACN-2-0002</b>	For P-SYSTEM	CNMG 09 SHIM	5,40 €
	<b>AACN-2-0003</b>	For S-SYSTEM	CCMT 12 SHIM	5,60 €
	<b>AACN-3-0001</b>	For T-M-P SYSTEM	CNMG 12 SHIM	5,60 €
		For C-SYSTEM	CNGN 12 SHIM	
	<b>AACN-3-0002</b>	For T-P SYSTEM	CNMG 16 SHIM	7,70 €
	<b>AACN-3-0003</b>	For T-P SYSTEM	CNMG 19 SHIM	12,80 €
<b>AACN-3-0008</b>	For T-P SYSTEM	CNMG 25 SHIM	20,40 €	
	<b>AAWN-2-0003</b>	For T-M-P SYSTEM	WNMG 08 THICK SHIM	7,70 €
	<b>AAWN-3-0001</b>	For T-M-P SYSTEM	WNMG 08 SHIM	5,60 €
	<b>AAWN-SW317</b>	For T-M-P SYSTEM	WNMG 06 SHIM	5,40 €
	<b>AKS-16L</b>	For C-SYSTEM	KNUX-L 16 SHIM	5,60 €
	<b>AKS-16R</b>	For C-SYSTEM	KNUX-R 16 SHIM	5,60 €
	<b>AASD-3-0001</b>	For S-SYSTEM MILLING	SDMT 12 SHIM	7,70 €
	<b>AASE-3-0001</b>	For S-SYSTEM MILLING	SEMT 13 SHIM	7,70 €
	<b>AASN-2-0001</b>	For S-SYSTEM	SCMT 09 SHIM	5,40 €
	<b>AASN-2-0002</b>	For P-SYSTEM	SNMG 09 SHIM	5,40 €
	<b>AASN-2-0004</b>	For S-SYSTEM	SCMT 12 SHIM	5,60 €
	<b>AASN-3-0004</b>	For T-P SYSTEM	SNMG 12 SHIM	5,60 €
		For C-SYSTEM	SNGN 12 SHIM	
	<b>AASN-3-0023</b>	For T-P SYSTEM	SNMG 15 SHIM	7,70 €
	<b>AASN-3-0005</b>	For T-P SYSTEM	SNMG 19 SHIM	12,80 €
	<b>AASN-3-0020</b>	For T-P SYSTEM	SNMG 25 SHIM	20,40 €
	<b>AASN-20020</b>	For PSDNN CARTRIDGE	SNMG 12 SHIM	10,20 €
		<b>AADN-2-0001</b>	For S-SYSTEM	DCMT 11 SHIM
For T-SYSTEM			DNMG 11 SHIM	
<b>AADN-SD317</b>		For P-SYSTEM	DNMG 11 SHIM	5,40 €
<b>AADN-3-0001</b>		For T-M-P SYSTEM	DNMG 15 SHIM	5,60 €
	For C-SYSTEM	DNGN 15 SHIM		
<b>AADN-2-0003</b>	For T-SYSTEM	DNMG 15 THICK SHIM	7,70 €	
	<b>AAVN-2-0002</b>	For S-SYSTEM	VBMT 16, VCMT 16 SHIM	5,60 €
		For T-SYSTEM	VNMG 16 SHIM	
	<b>AARC-3-0001</b>	For C-SYSTEM	RCGX 06 SHIM	13,20 €
	<b>AARC-3-0002</b>	For C-SYSTEM	RCGX 09 SHIM	13,20 €
	<b>AARC-3-0003</b>	For C-SYSTEM	RCGX 12 SHIM	13,20 €

SPARE PARTS / ERSATZTEILE

CLAMPS

PRODUCT PICTURE	CODE	PRODUCT DETAIL		PRICE / PREIS
	<b>ATK-01</b>	For T-SYSTEM	DNMG 11, WNMG 06, TNMG 16, CNMG 09 CLAMP	6,60 €
	<b>ATK-02</b>	For T-SYSTEM	CNMG 12, WNMG 08, TNMG 22, DNMG 15, SNMG 12 CLAMP	6,60 €
	<b>ATK-03</b>	For T-SYSTEM	VNMG 16 CLAMP	6,60 €
	<b>ATK-04</b>	For T-SYSTEM	CNMG 16, SNMG 15 CLAMP	6,60 €
	<b>AMK-01</b>	For M-SYSTEM	WNMG 06 CLAMP	6,60 €
	<b>AMK-02</b>	For M-SYSTEM	INTERNAL Ø20 TNMG 16 Ø25 MT-NR/L 16 CLAMP	6,60 €
	<b>AMK-03</b>	For M-SYSTEM	DNMG 11, CNMG 12 CLAMP	6,60 €
	<b>AMK-04</b>	For M-SYSTEM	DNMG 15, TNMG 16-22 CLAMP	6,60 €
	<b>AMK-05</b>	For M-SYSTEM	WNMG 08 CLAMP	6,60 €
	<b>AMK-07</b>	For M-SYSTEM	S20R MCLNR/L CLAMP	6,60 €
	<b>ACK-01-R</b>	For C-SYSTEM	KNUX-R CLAMP	6,60 €
	<b>ACK-02-L</b>	For C-SYSTEM	KNUX-L CLAMP	6,60 €
	<b>ACK-03</b>	For C-SYSTEM	154.91 EXTERNAL and INTERNAL Ø25-Ø32 CLAMP	6,60 €
	<b>ACK-04</b>	For P-C-SYSTEM	CTFPR CARTRIDGE CLAMP	6,60 €
	<b>ACK-05</b>	For P-C-SYSTEM	ADDITIONAL LITTLE CLAMP for MILLING and THREADING TOOLS	6,60 €
	<b>ACK-06</b>	For C-SYSTEM	154.91 INTERNAL Ø16-Ø20 CLAMP	6,60 €
	<b>ACK-07</b>	For C-SYSTEM	SPARE PART SET of CNGN, SNGN, DNGN (CLAMP + CLAMP SCREW + RING)	12,10 €
	<b>ACK-08</b>	For C-SYSTEM	SPARE PART SET of TNGN, (CLAMP + CLAMP SCREW + RING)	12,10 €
	<b>ACK-09</b>	For P-SYSTEM	ADDITIONAL BIG CLAMP for CNMG 16-19, SNMG 15-19	6,60 €
	<b>ACK-10</b>	For C-SYSTEM MILLING	SPKN 12 ve Ø50-Ø63 TPKN 16 CLAMP (M8x8)	6,60 €
	<b>ACK-11</b>	For C-SYSTEM MILLING	Ø80-Ø100 TPKN 16-TPKN 22, OFKR 07, HNMX 09 CLAMP (M8x10)	6,60 €
	<b>ACK-12</b>	For C-SYSTEM	CTSPR CATRIDGE CLAMP	6,60 €
	<b>ACK-15</b>	For S-SYSTEM MILLING	RD.. 10-12 CLAMP	6,60 €
	<b>ACK-19</b>	For S-SYSTEM MILLING	WD0805D CLAMP	6,60 €
	<b>ACK-23</b>	For C-SYSTEM	SPARE PART SET of DNGN 11, (CLAMP + CLAMP SCREW + RING)	12,10 €
	<b>ACK-24</b>	For S-SYSTEM MILLING	XD0806D CLAMP	6,60 €
	<b>ACK-27</b>	For C-SYSTEM	RCGX 06 CLAMP	13,20 €
	<b>ACK-28</b>	For C-SYSTEM	RCGX 09 CLAMP	13,20 €
	<b>ACK-29</b>	For C-SYSTEM	RCGX 12 CLAMP	13,20 €

**SPARE PARTS / ERSATZTEILE**
**CLAMP SCREWS**

PRODUCT PICTURE	CODE	PRODUCT DETAIL		PRICE / PREIS
	<b>AKV-01-M5X22</b>	For T-SYSTEM	DNMG 11, WNMG 06, TNMG 16 CLAMP SCREW (M5X20)	1,80 €
	<b>AKV-02-M6X22</b>	For T-SYSTEM	CNMG 12, WNMG 08, TNMG 22, DNMG 15, SNMG 12-15 VNMG 16 CLAMP SCREW (M6X20)	1,80 €
For M-SYSTEM		TNMG 16-22, DNMG 15 CLAMP SCREW (M6X20)		
	<b>AKV-03-M6X22</b>	For M-SYSTEM	WNMG 08 CLAMP SCREW (M6X20)	1,80 €
	<b>AKV-04-M5X17</b>	For M-SYSTEM	S20R MT-NR/L 16, S20R-S25S MWLNR/L 06, S25S MDUNR/L11- EXTERNAL MWLNR 06 (M5X20)	1,80 €
		<b>AKV-05-M6X25</b>	For T-SYSTEM	CNMG 16 CLAMP SCREW (M6X25)
	<b>AKV-06-M6X20</b>	For C-SYSTEM	KNUX 16 CLAMP SCREW (M6X20)	2,20 €
	<b>AKV-07-M6X22</b>	For C-SYSTEM	ADKT-154.91, AIKT-154.91-R/L-32 CLAMP SCREW (M6X20)	1,80 €
	<b>AKV-10-M6X14</b>	For C-SYSTEM	AIKT-154.91-R/L-16, AIKT-154.91-R/L-20, AIKT-154.91-R/L-25 CLAMP SCREW (M6X15)	1,80 €
		<b>AKV-11-M8X29</b>	For C-SYSTEM	TNGN, CNGN, DNGN, SNGN CLAMP SCREW (M8X33)
	<b>AAV-05-M6X15</b>	For P-SYSTEM	CNMG 16-19, SNMG 15-19 ADDITIONAL BIG CLAMP SCREW (M6X15)	1,80 €
	<b>AKV-12-M5X12</b>	For C-SYSTEM	CTSPR CLAMP SCREW (M5X9)	1,80 €
	<b>AKV-13-M8X1X16</b>	For C-SYSTEM MILLING	SPKN 12 ve Ø63 TPKN 16 CLAMP SCREW (M8X1X16)	2,20 €
		<b>AKV-14-M8X1X18</b>	For C-SYSTEM MILLING	Ø80-Ø100 TPKN 16 ve Ø63-Ø315 TPKN 22 CLAMP SCREW (M8X1X18)
	<b>AKV-15-M8X1X20</b>	For C-SYSTEM MILLING	OFKR 07, HNMX 09 CLAMP SCREW (M8X1X20)	2,20 €
	<b>AKV-16-M6X16</b>	For C-SYSTEM	CTFPR 13CS 16 CLAMP SCREW (M6X16)	2,20 €
	<b>AKV-17-M5X15</b>	For M-SYSTEM	S16P MWLNR/L CLAMP SCREW (M5X18)	1,80 €
		<b>AKV-19-M7X25</b>	For T-SYSTEM	CNMG 16 CLAMP SCREW (M7X25)
	<b>AKV-20-M6X19</b>	For M-SYSTEM	S25S MDUNR/L 15 CLAMP SCREW (M6X19)	1,80 €
	<b>AKV-21-M6X18</b>	For C-SYSTEM	AIKT-154.91-R/L-25 CLAMP SCREW (M6X18)	1,80 €
		<b>AKV-22-M8X1X14</b>	For C-SYSTEM MILLING	Ø50 TPKN 16 CLAMP SCREW (M8X1X14)
	<b>AKV-27-M6X20</b>	For M-SYSTEM	S25S MWLNR/L 08 CLAMP SCREW	1,80 €

SPARE PARTS / ERSATZTEILE

SHIM SCREWS				
PRODUCT PICTURE	CODE	PRODUCT DETAIL		PRICE / PREIS
	<b>AAV-01-M3X10</b>	For T-SYSTEM	WNMG 06, KNUX 16 SHIM SCREW	1,10 €
	<b>AAV-02-M5X12</b>	For T-SYSTEM	CNMG 12, WNMG 08, TNMG 22, DNMG 15, SNMG 12	1,10 €
		For C-SYSTEM	CNGN 12, SNGN 12, DNGN 15 SHIM SCREW	
	<b>AAV-03-M5X12</b>	For T-SYSTEM	TNMG 16 SHIM SCREW	1,10 €
		For C-SYSTEM	TNGN 16 SHIM SCREW	
	<b>AAV-04-M5X12</b>	For T-SYSTEM	VNMG 16, DNMG 11, CNMG 09 SHIM SCREW	1,10 €
	<b>AAV-05-M6X15</b>	For T-SYSTEM	CNMG 16 SHIM SCREW	1,80 €
	<b>AAV-06-M3.5X11</b>	For S-SYSTEM	CCMT 09, DCMT 11, VBMT 16, VCMT 16	3,30 €
			TCMT 16, For THREADING 16 SHIM SCREW (M3.5 SHIM SCREW)	
	<b>AAV-07-M4.5X13</b>	For S-SYSTEM	CCMT 12, SCMT 12, For THREADING 22	3,30 €
			SHIM SCREW (M4.5 SHIM SCREW)	
	<b>AAV-08-M3.5X8</b>	For S-SYSTEM	(M3.5x8 SHIM SCREW)	3,30 €
	<b>AAV-09-M5X9</b>	For T-SYSTEM	S25S TCLNR/L 09, S25S TDUNR/L 11, S25S TDQNR/L 11 SHIM SCREW	1,10 €
	<b>AAV-10-M4.5X8</b>	For S-SYSTEM	(M4.5x8 SHIM SCREW)	3,30 €
	<b>AAV-11-U5-40X4.5</b>	For S-SYSTEM	For THREADING TOOLHOLDERS 16 ER/L, 16 IR/L SHIM SCREW	2,20 €
	<b>AAV-12-U8-32X5.5</b>	For S-SYSTEM	For THREADING TOOLHOLDERS 22 ER/L, 22 IR/L SHIM SCREW	2,20 €
<b>AAV-13-M5X8</b>	For T-SYSTEM	S25S TSKNR/L 12, S25S TCLNR/L 12, S25S TWLNR/L 08 SHIM SCREW	1,10 €	
<b>AAV-14-M5X20</b>	For ATUM	ADCR CHAMFERING RING TOOLS MOUNTING SCREW	1,10 €	
<b>AAV-15-M5X5.7</b>	For S-SYSTEM	For THREADING TOOLHOLDERS 27 ER/L, 27 IR/L SHIM SCREW	2,20 €	
<b>AAV-16-M3.5X8</b>	For S-SYSTEM	SEMT 13 SHIM SCREW	3,30 €	

PINS				
PRODUCT PICTURE	CODE	PRODUCT DETAIL		PRICE / PREIS
	<b>APM-01</b>	For M-SYSTEM	INTERNAL Ø25-Ø32-Ø40 and EXTERNAL TNMG 16 PIN	2,20 €
	<b>APM-02</b>	For M-SYSTEM	TNMG 22, WNMG 08 PIN	2,20 €
	<b>APM-03</b>	For M-SYSTEM	S20R MTFNR/L 16, S20R MT-NR/L 16, S20R MTUNR/L 16, S20R MTQNR/L 16, S20R MDUNR/L 11PIN	2,20 €
	<b>APM-04</b>	For M-SYSTEM	S32T MCLNR/L 12, DNMG 15, S25S MWLNR/L 08 PIN	2,20 €
	<b>APM-05</b>	For M-SYSTEM	MSYNR 11.5CS 12 For CARTRIDGE SNMG 12 PIN	4,40 €
	<b>APM-06</b>	For C-SYSTEM	154.91 PIN	2,20 €
	<b>APM-07</b>	For M-SYSTEM	S20R ET-NR 16 PIN	6,60 €
	<b>APM-08</b>	For M-SYSTEM	S25S MWLNR/L 06, EXTERNAL PIN	2,20 €
	<b>APM-09</b>	For M-SYSTEM	S16P MWLNR/L 06 PIN	2,20 €
	<b>APM-10</b>	For M-SYSTEM	S20R MWLNR/L 06 PIN	2,20 €
	<b>APM-11</b>	For M-SYSTEM	S20R MTQNR/L 16 PIN	2,20 €
	<b>APM-12</b>	For M-SYSTEM	S20R MCLNR/L 12, S25S MCLNR/L 12-Z PIN	2,20 €
	<b>APM-13</b>	For M-SYSTEM	S25S MCLNR/L 12 PIN	2,20 €
	<b>APM-14</b>	For M-SYSTEM	S25S MTFNR/L 16, S25S MT-NR/L 16, S25S MTUNR/L 16, S25S MTQNR/L 16 PIN	2,20 €
	<b>APM-15</b>	For M-SYSTEM	MSYNR 16CS 12 For CARTRIDGE SNMG 12 PIN	4,40 €

**SPARE PARTS / ERSATZTEILE**
**RING**

PRODUCT PICTURE	CODE	PRODUCT DETAIL		PRICE / PREIS
	<b>ACS-01</b>	For C-SYSTEM	TNGN, CNGN, DNGN, SNGN, RING	1,10 €

**STAMP**

PRODUCT PICTURE	CODE	PRODUCT DETAIL		PRICE / PREIS
	<b>ABPL-01</b>	For T-SYSTEM	DNMG 11-15, WNMG 06-08, TNMG 16-22, VNMG 16, CNMG 12, SNMG 12 STAMP	0,20 €
		For M-SYSTEM	INTERNAL Ø25-Ø32-Ø40 and EXTERNAL TNMG 16-22, DNMG 15, WNMG 08 STAMP	
		For C-SYSTEM	KNUX 16 STAMP	
	<b>ABPL-02</b>	For T-SYSTEM	CNMG 16 STAMP	0,20 €

**CLAMP SPRING**

PRODUCT PICTURE	CODE	PRODUCT DETAIL		PRICE / PREIS
	<b>AKY-01</b>	For T-SYSTEM	CNMG 12, WNMG 08, TNMG 22, DNMG 15, SNMG 12, VNMG 16 CLAMP SPRING	1,10 €
	<b>AKY-02</b>	For C-SYSTEM	KNUX 16 CLAMP SPRING	1,10 €

**LEVERS**







PRODUCT PICTURE	CODE	PRODUCT DETAIL		PRICE / PREIS
	<b>APL-01</b>	For P-SYSTEM	CNMG 09, DNMG 11, SNMG 09, TNMG 16, WNMG 06 LEVER	7,70 €
	<b>APL-02</b>	For P-SYSTEM	CNMG 12, SNMG 12, TNMG 22, WNMG 08 LEVER	7,70 €
	<b>APL-03</b>	For P-SYSTEM	DNMG 15 LEVER	7,70 €
	<b>APL-04</b>	For P-SYSTEM	CNMG 16, SNMG 15 LEVER	7,70 €
	<b>APL-05</b>	For P-SYSTEM	CNMG 19, SNMG 19 LEVER	13,20 €
	<b>APL-06</b>	For P-SYSTEM	CNMG 25, SNMG 25 LEVER	19,80 €
	<b>APL-07</b>	For P-SYSTEM	S16P PCLNR/L 09, S16P PTUNR/L 16 LEVER	7,70 €
	<b>APL-08</b>	For P-SYSTEM	S16P PTUNR/L 16 LEVER	7,70 €

**LEVER SCREWS**

PRODUCT PICTURE	CODE	PRODUCT DETAIL		PRICE / PREIS
	<b>ALV-01-M6X14</b>	For P-SYSTEM	INTERNAL Ø20 DNMG 11 Ø20 TNMG 16 LEVER SCREW (M6X14)	2,60 €
	<b>ALV-02-M6X17</b>	For P-SYSTEM	DNMG 11, TNMG 16, WNMG 06 LEVER SCREW (M6X17)	2,60 €
	<b>ALV-03-M8X19</b>	For P-SYSTEM	CNMG 12, SNMG 12, TNMG 22, WNMG 08, DNMG 15 LEVER SCREW (M8X19)	2,60 €
	<b>ALV-04-M8X22</b>	For P-SYSTEM	CNMG 16, SNMG 15 LEVER SCREW (M8X22)	2,60 €
	<b>ALV-05-M10X27</b>	For P-SYSTEM	CNMG 19, SNMG 19 LEVER SCREW (M10X27)	3,10 €
	<b>ALV-06-M12X36</b>	For P-SYSTEM	CNMG 25, SNMG 25 LEVER SCREW (M12X36)	5,70 €
	<b>ALV-07-M6X13</b>	For P-SYSTEM	S16P PCLNR/L 09, S16P PCTUR/L 16 LEVER SCREW (M6X13)	2,60 €
	<b>ALV-08-M8X17</b>	For P-SYSTEM	S25S PCLNR/L 12, S25S PDUNR/L 15, S25S PSKNR/L 12 LEVER SCREW	2,60 €

SPARE PARTS / ERSATZTEILE

TORX SCREWS

PRODUCT PICTURE	CODE	PRODUCT DETAIL		PRICE / PREIS	
	4006-M1.6X3.2	For S-SYSTEM	TORK SCREW	4,40 €	
	3006-M1.8X4	For S-SYSTEM	TORK SCREW	5,50 €	
	3006-M2X4	For S-SYSTEM	TORK SCREW	3,60 €	
	4006-M2X5	For S-SYSTEM	TORK SCREW	2,20 €	
	3007-M2.2X5	For S-SYSTEM	TORK SCREW	3,60 €	
	4006-M2.2X5	For S-SYSTEM	TORK SCREW	2,20 €	
	1008-M2.5X5	For S-SYSTEM	TORK SCREW	1,10 €	
	1008-M2.5X7	For S-SYSTEM	TORK SCREW	1,10 €	
	1108-M2.5x6	For S-SYSTEM	TORK SCREW	6,60 €	
	3008-M2.5X5	For S-SYSTEM	TORK SCREW	3,60 €	
	3008-M2.5X6	For S-SYSTEM	TORK SCREW	3,60 €	
	4007-M2.5X4.5	For S-SYSTEM	TORK SCREW	2,20 €	
	4008-M2.5X4	For S-SYSTEM	TORK SCREW	2,20 €	
	4008-M2.5X4.5	For S-SYSTEM	TORK SCREW	2,20 €	
	4008-M2.5X6	For S-SYSTEM	TORK SCREW	2,20 €	
	4108-M2.5x8	For S-SYSTEM	TORK SCREW	2,20 €	
	1008-M3X6	For S-SYSTEM	TORK SCREW	1,10 €	
	1008-M3X8	For S-SYSTEM	TORK SCREW	1,10 €	
	3008-M3X6	For S-SYSTEM	TORK SCREW	3,60 €	
	3008-M3X7	For S-SYSTEM	TORK SCREW	3,60 €	
	3008-M3X8	For S-SYSTEM	TORK SCREW	3,60 €	
	3108-M3X8	For S-SYSTEM	TORK SCREW	3,60 €	
	4008-M3X8	For S-SYSTEM	TORK SCREW	2,20 €	
	4010-M3X6	For S-SYSTEM	TORK SCREW	2,20 €	
	4010-M3X8	For S-SYSTEM	TORK SCREW	2,20 €	
		1015-M3.5X9	For S-SYSTEM	TORK SCREW	1,10 €
1015-M3.5X11		For S-SYSTEM	TORK SCREW	1,10 €	
1015-M3.5X14		For S-SYSTEM	TORK SCREW	1,10 €	
1315-M3.5X11		For S-SYSTEM	TORK SCREW	1,10 €	
1410-M3.5X9		For S-SYSTEM	TORK SCREW	1,10 €	
1510-M3.5X7		For S-SYSTEM	TORK SCREW	1,10 €	
1510-M3.5X9		For S-SYSTEM	TORK SCREW	1,10 €	
1615-M3.5X10		For S-SYSTEM	TORK SCREW	1,10 €	
1615-M3.5X11		For S-SYSTEM	TORK SCREW	1,10 €	
1615-M3.5X15		For S-SYSTEM	TORK SCREW	1,10 €	
		3010-M3.5X7	For S-SYSTEM	TORK SCREW	3,60 €
		3010-M3.5X9	For S-SYSTEM	TORK SCREW	3,60 €
	3015-M3.5X9	For S-SYSTEM	TORK SCREW	3,60 €	
	4015-M3.5X8	For S-SYSTEM	TORK SCREW	2,20 €	
	4015-M3.5X9	For S-SYSTEM	TORK SCREW	2,20 €	
	4015-M3.5X10	For S-SYSTEM	TORK SCREW	2,20 €	
	4015-M3.5X11	For S-SYSTEM	TORK SCREW	2,20 €	
	4015-M3.5X12	For S-SYSTEM	TORK SCREW	2,20 €	
	4015-M3.5X14	For S-SYSTEM	TORK SCREW	2,20 €	
	1015-M4X9	For S-SYSTEM	TORK SCREW	3,30 €	
	1515-M4X9	For S-SYSTEM	TORK SCREW	1,10 €	
		1115-M4x10	For S-SYSTEM	TORK SCREW	6,60 €
1015-M4X11		For S-SYSTEM	TORK SCREW	3,30 €	
1315-M4X11		For S-SYSTEM	TORK SCREW	1,10 €	
1415-M4X11		For S-SYSTEM	TORK SCREW	1,10 €	
1515-M4X11		For S-SYSTEM	TORK SCREW	1,10 €	
1615-M4X11		For S-SYSTEM	TORK SCREW	1,10 €	
3015-M4X9		For S-SYSTEM	TORK SCREW	3,60 €	
3015-M4X11		For S-SYSTEM	TORK SCREW	3,60 €	
4015-M4X9		For S-SYSTEM	TORK SCREW	2,20 €	
4015-M4X11		For S-SYSTEM	TORK SCREW	2,20 €	
		4015-M4X12	For S-SYSTEM	TORK SCREW	2,20 €
		4615-M4X11	For S-SYSTEM	TORK SCREW	2,20 €
	1015-M4.5X12		TORK SCREW	1,10 €	

**SPARE PARTS / ERSATZTEILE**
**TORX SCREWS**

PRODUCT PICTURE	CODE	PRODUCT DETAIL		PRICE / PREIS
	<b>1020-M4.5X16</b>	For S-SYSTEM	TORK SCREW	1,10 €
	<b>1120-M4.5X12</b>	For S-SYSTEM	TORK SCREW	3,30 €
	<b>1515-M4.5X11</b>	For S-SYSTEM	TORK SCREW	1,10 €
	<b>4015-M4.5X11</b>	For S-SYSTEM	TORK SCREW	2,20 €
	<b>4020-M4.5X10</b>	For S-SYSTEM	TORK SCREW	2,20 €
	<b>4020-M4.5X12</b>	For S-SYSTEM	TORK SCREW	2,20 €
	<b>1020-M5X11</b>	For S-SYSTEM	TORK SCREW	1,10 €
	<b>1020-M5X14</b>	For S-SYSTEM	TORK SCREW	1,10 €
	<b>1615-M5x14</b>	For S-SYSTEM	TORK SCREW	3,30 €
	<b>1620-M5X18</b>	For S-SYSTEM	TORK SCREW	3,60 €
	<b>1620-M5X22</b>	For S-SYSTEM	TORK SCREW	3,60 €
	<b>4420-M5X14</b>	For S-SYSTEM	TORK SCREW	2,20 €
	<b>1020-M6X16</b>	For S-SYSTEM	TORK SCREW	1,50 €
	<b>1420-M6X16</b>	For S-SYSTEM	TORK SCREW	1,50 €
	<b>1520-M6X16</b>	For S-SYSTEM	TORK SCREW	1,50 €
	<b>1710-U5-40X12.2</b>	For S-SYSTEM	TORK SCREW	3,60 €
	<b>1720-U8-32X15</b>	For S-SYSTEM	TORK SCREW	3,60 €
	<b>1707-U4-48X8.2</b>	For S-SYSTEM	TORK SCREW	5,50 €

**SHIM SPRING**

PRODUCT PICTURE	CODE	PRODUCT DETAIL		PRICE / PREIS
	<b>AAY-01</b>	For P-SYSTEM	DNMG 11, TNMG 16, WNMG 06, CNMG 09, SNMG 09 SHIM SPRING	1,50 €
	<b>AAY-02</b>	For P-SYSTEM	CNMG 12, SNMG 12, TNMG 22, WNMG 08, DNMG 15 SHIM SPRING	1,50 €
	<b>AAY-03</b>	For P-SYSTEM	CNMG 16, SNMG 15 SHIM SPRING	1,50 €
	<b>AAY-04</b>	For P-SYSTEM	CNMG 19, SNMG 19 SHIM SPRING	1,50 €
	<b>AAY-05</b>	For P-SYSTEM	CNMG 25, SNMG 25 SHIM SPRING	2,90 €

**PROFIL MILLING SCREWS**

PRODUCT PICTURE	CODE	PRODUCT DETAIL	PRICE / PREIS
	<b>1208-M3x7</b>	PROFIL MILLING SCREW-P3208 INSERT SCREW	6,60 €
	<b>1215-M4X0.5X9</b>	PROFIL MILLING SCREW-P3210-ROHX 12 INSERT SCREW	6,60 €
	<b>1220-M5X0.5X9</b>	PROFIL MILLING SCREW-P3212 INSERT SCREW	6,60 €
	<b>1220-M5X0.5X12</b>	PROFIL MILLING SCREW-P3216-ROHX 16 INSERT SCREW	6,60 €
	<b>1220-M5X0.5X15</b>	PROFIL MILLING SCREW-P3220-ROHX 20 INSERT SCREW	6,60 €
	<b>1220-M6X0.75X20</b>	PROFIL MILLING SCREW-P3225 INSERT SCREW	8,80 €
	<b>1204-M8X0.75X26</b>	PROFIL MILLING SCREW-P3232 INSERT SCREW	11,00 €
	<b>1210-M3.5X9.6</b>	PROFIL MILLING SCREW-BNM 12 INSERT SCREW	11,00 €
	<b>1215-M4X13.5</b>	PROFIL MILLING SCREW-BNM 16 INSERT SCREW	11,00 €



SPARE PARTS / ERSATZTEILE

EXCENTRIC SCREW

PRODUCT PICTURE	CODE	PRODUCT DETAIL	PRICE / PREIS
	<b>AEV-01-M6x16</b>	CARTRIDGE EXCENTRIC SCREW	6,60 €

MOUNTING and ADJUSTING SCREWS

PRODUCT PICTURE	CODE	PRODUCT DETAIL	PRICE / PREIS
	<b>2406-M8x30</b>	A16 MOUNTING SCREW (SMALL HEAD)	1,80 €
	<b>2506-M8x30</b>	A16 MOUNTING SCREW	1,80 €
	<b>2407-M10x30</b>	A22 MOUNTING SCREW	1,80 €
	<b>2408-M10x30</b>	A22 MOUNTING SCREW (SMALL HEAD)	1,80 €
	<b>2508-M10x30</b>	A22 MOUNTING SCREW	1,80 €
	<b>2408-M12x35</b>	A27 MOUNTING SCREW	1,80 €
	<b>2410-M12x35</b>	A27 MOUNTING SCREW (SMALL HEAD)	1,80 €
	<b>2510-M12x35</b>	A27 MOUNTING SCREW	1,80 €
	<b>2514-M16x35</b>	A32 MOUNTING SCREW	1,80 €
	<b>2504-M5x16</b>	CARTRIDGE MOUNTING SCREW	1,80 €
	<b>2505-M6x16</b>	CARTRIDGE MOUNTING SCREW	1,80 €
	<b>2505-M6x40</b>	CARTRIDGE MOUNTING SCREW	1,80 €
	<b>2506-M8x20</b>	CARTRIDGE MOUNTING SCREW	1,80 €
	<b>AKV-23-M4x10</b>	CARTRIDGE MOUNTING SCREW	1,80 €
	<b>2600-M4x9.5</b>	CARTRIDGE AXIAL ADJUST SCREW	1,80 €
	<b>2600-M5x13</b>	CARTRIDGE AXIAL ADJUST SCREW	1,80 €
	<b>2600-M6x18</b>	CARTRIDGE AXIAL ADJUST SCREW	1,80 €
	<b>2725-M5x6</b>	CARTRIDGE RADIAL ADJUST SCREW	1,10 €
<b>2725-M5x10</b>	CARTRIDGE RADIAL ADJUST SCREW	1,10 €	

ALLEN KEYS

PRODUCT PICTURE	CODE	PRODUCT DETAIL	PRICE / PREIS
	<b>AAL-01-2 mm</b>	ALLEN KEY	1,10 €
	<b>AAL-02-2.5 mm</b>	ALLEN KEY	1,10 €
	<b>AAL-03-3 mm</b>	ALLEN KEY	1,10 €
	<b>AAL-05-4 mm</b>	ALLEN KEY	1,30 €
	<b>AAL-07-5 mm</b>	ALLEN KEY	1,80 €
	<b>AAL-08-6 mm</b>	ALLEN KEY	2,75 €
	<b>AAL-09-1.5 mm</b>	ALLEN KEY	1,10 €
	<b>AAL-11-8 mm</b>	ALLEN KEY	4,40 €
	<b>AAL-12-10 mm</b>	ALLEN KEY	6,60 €

TORX KEYS

PRODUCT PICTURE	CODE	PRODUCT DETAIL	PRICE / PREIS
	<b>80-T6</b>	TORX KEY	3,30 €
	<b>80-T7</b>	TORX KEY	3,30 €
	<b>80-T8</b>	TORX KEY	3,30 €
	<b>80-T10</b>	TORX KEY	3,30 €
	<b>80-T15</b>	TORX KEY	3,30 €
	<b>80-T20</b>	TORX KEY	3,30 €
	<b>81-T15</b>	T-TYPE TORX KEY	3,30 €
	<b>81-T20</b>	T-TYPE TORX KEY	3,30 €

**SPARE PARTS / ERSATZTEILE**
**ROUGH BORING HEADS**

PRODUCT PICTURE	CODE	PRODUCT DETAIL	PRICE / PREIS
	<b>ABKS-D16</b>	ABKS-D16 CARTRIDGE FIXING CLAMP	6,60 €
	<b>ABKS-D20</b>	ABKS-D20 CARTRIDGE FIXING CLAMP	6,60 €
	<b>ABKS-D25</b>	ABKS-D25 CARTRIDGE FIXING CLAMP	6,60 €
	<b>ABKS-D32</b>	ABKS-D32 CARTRIDGE FIXING CLAMP	6,60 €
	<b>ABKS-D40</b>	ABKS-D40 CARTRIDGE FIXING CLAMP	6,60 €
	<b>ABKS-D50</b>	ABKS-D50 CARTRIDGE FIXING CLAMP	11,00 €
	<b>ABKS-D63</b>	ABKS-D63 CARTRIDGE FIXING CLAMP	11,00 €
	<b>ABKS-D80</b>	ABKS-D80 CARTRIDGE FIXING CLAMP	11,00 €
	<b>2525-M3X14</b>	2525-M3X14 CARTRIDGE MOUNTING SCREW	1,80 €
	<b>2503-M4X15</b>	2503-M4X15 CARTRIDGE MOUNTING SCREW	1,80 €
	<b>2503-M4X20</b>	2503-M4X20 CARTRIDGE MOUNTING SCREW	1,80 €
	<b>2504-M5X25</b>	2504-M5X25 CARTRIDGE MOUNTING SCREW	1,80 €
	<b>2505-M6X30</b>	2505-M6X30 CARTRIDGE MOUNTING SCREW	1,80 €
	<b>2506-M8X35</b>	2506-M8X35 CARTRIDGE MOUNTING SCREW	1,80 €
	<b>2508-M10X40</b>	2508-M10X40 CARTRIDGE MOUNTING SCREW	1,80 €
	<b>2510-M12X40</b>	2510-M12X40 CARTRIDGE MOUNTING SCREW	1,80 €
	<b>2715-M3X4</b>	2715-M3X4 CARTRIDGE MOUNTING SCREW	1,10 €
	<b>2715-M3X5</b>	2715-M3X5 CARTRIDGE RADIAL ADJUST SCREW	1,10 €
	<b>2715-M3X8</b>	2715-M3X8 CARTRIDGE RADIAL ADJUST SCREW	1,10 €
	<b>2702-M4X12</b>	2702-M4X12 CARTRIDGE RADIAL ADJUST SCREW	1,10 €
<b>2725-M5X12</b>	2725-M5X12 CARTRIDGE RADIAL ADJUST SCREW	1,10 €	
<b>2725-M5X14</b>	2725-M5X14 CARTRIDGE RADIAL ADJUST SCREW	1,10 €	
<b>2703-M6X16</b>	2703-M6X16 CARTRIDGE RADIAL ADJUST SCREW	1,10 €	
<b>2704-M8X25</b>	2704-M8X25 CARTRIDGE RADIAL ADJUST SCREW	1,10 €	

**GROOVING TOOLS SCREWS**

PRODUCT PICTURE	CODE	PRODUCT DETAIL	PRICE / PREIS
	<b>AKV-02-M6x20</b>	GROOVING TOOL SCREW	1,80 €
	<b>2503-M4x10</b>	GROOVING TOOL SCREW	1,80 €
	<b>2503-M4x16</b>	GROOVING TOOL SCREW	1,80 €
	<b>2504-M5x12</b>	GROOVING TOOL SCREW	1,80 €
	<b>2504-M5x16</b>	GROOVING TOOL SCREW	1,80 €
	<b>2505-M6x16</b>	GROOVING TOOL SCREW	1,80 €
	<b>2505-M6x20</b>	GROOVING TOOL SCREW	1,80 €
	<b>2004-M8x20</b>	GROOVING TOOL SCREW	2,20 €
	<b>2004-M8x1x20</b>	GROOVING TOOL SCREW	2,20 €
	<b>1904-M8x1x20</b>	GROOVING TOOL SCREW	2,20 €

**BLOCKS For PARTING and DEEP GROOVING BLADE CLAMPS**

PRODUCT PICTURE	CODE	PRODUCT DETAIL	PRICE / PREIS
	<b>ABK-01</b>	For BLADE ALBU-20-26 CLAMP	22,00 €
	<b>ABK-02</b>	For BLADE ALBU-25-26 CLAMP	22,00 €
	<b>ABK-03</b>	For BLADE ALBU-20-32 CLAMP	24,20 €
	<b>ABK-04</b>	For BLADE ALBU-25-32, ALBU-32-32 CLAMP	24,20 €

**BLADE KEY**

PRODUCT PICTURE	CODE	PRODUCT DETAIL	PRICE / PREIS
	<b>ALA-01</b>	AKL BLADE KEY	13,20 €

$\alpha$  = 5 Kat Dayanıklılık

$\alpha$  = 5 Times Long Life

## Alfa Kaplamanın Avantajları

### Alpha Coating Advantages

- **Yüksek aşınma direnci**  
High resistance to abrasion
- **Yüksek yüzey sertliği**  
750-800 Vickers  
High surface hardness  
750-800 Vickers
- **Temperlemeye karşı yüksek direnç**  
High resistance to tempering
- **Yüksek yorulma mukavemeti**  
High fatigue strength
- **Yüksek çizik ve çentik direnci**  
High scratch and impact resistance
- **Paslanmaz olmayan çelikler için daha yüksek korozyon direnci**  
Resistant to corrosion of non-stainless steel

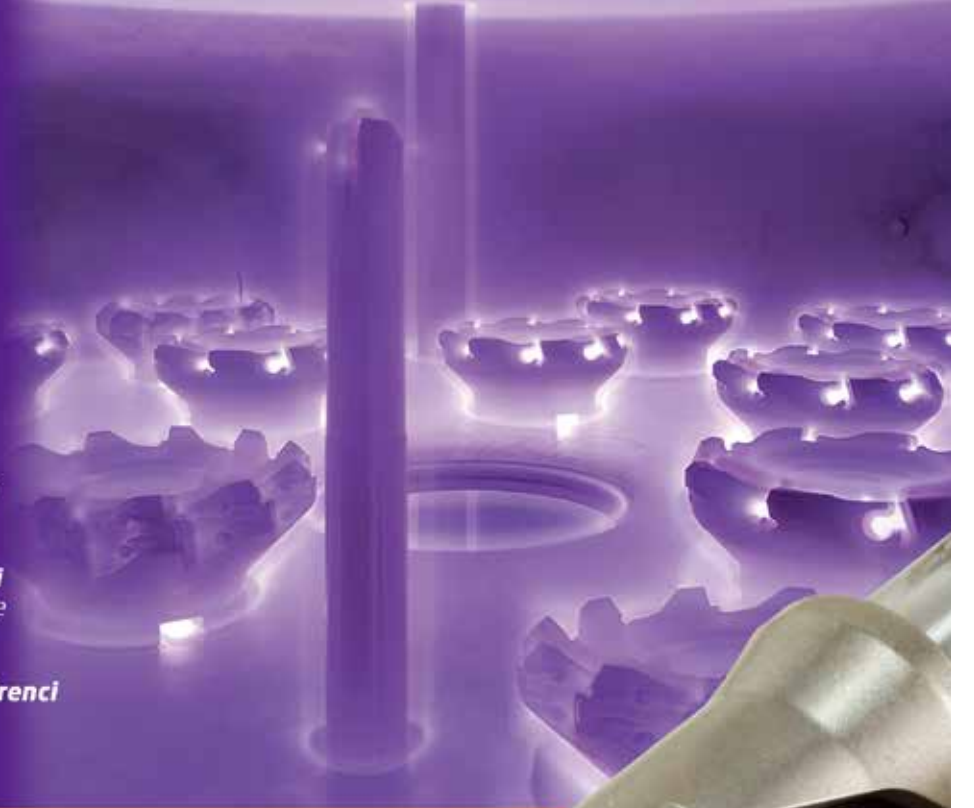

takımınız neden  
**daha uzun ömürlü**  
olmasın?...

**longer tool life...**



$\alpha$  Çevre Dostudur.  $\alpha$  is friend of environment.

İnsan sağlığı açısından zararlı değildir. Is not harmful to human health.

Gaz ve diğer atıkları çevreyi kirletmez. Gas and other wastes will not pollute the environment.

